

THIS DOCUMENT CONTAINS  
INTEL CONFIDENTIAL  
INFORMATION PROVIDED  
UNDER NON-DISCLOSURE  
AGREEMENT OR THE INTEL®  
CHANNEL PARTNER  
PROGRAM TERMS AND  
CONDITIONS.

# Intel® Product Quick Reference Matrix Q4 2008

[Intel® Channel Partner Program Letter  
Technology Update](#)  
[Intel® Modular Server Sales Guide](#)  
[Intel® vPro™ Processor Technology Solution](#)  
[Desktop Platforms Matrix](#)  
[Mobile Platforms Matrix](#)  
[Server Platforms Matrix](#)  
[Intel® Desktop Processors](#)  
[Intel® Desktop Boards and  
Intel® Desktop Adapters](#)  
[Intel® Graphics Product Matrix](#)  
[Intel® Mobile Processors and  
Intel® PRO/Wireless Network Connections](#)  
[Intel® Server/Workstation Processors](#)  
[Intel® Server Boards](#)  
[Intel® Server Essentials](#)  
[Intel® Server Chassis](#)  
[Intel® Server Systems](#)  
[Intel® Server Adapters](#)  
[Intel® RAID Controllers](#)  
[Intel® Management Modules](#)  
[Intel® Storage Systems](#)  
[Intel® Modular Server Products](#)  
[Intel® Enabled Server Acceleration Alliance](#)

All products and dates specified  
are preliminary based on current  
expectations and are subject to  
change without notice.  
Availability in different channels  
may vary.



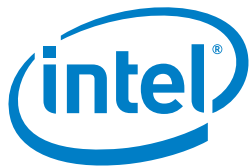

## Dear Intel® Channel Partner Program member:

We're already looking ahead to 2009 to see how you can move your business forward with our next big steps in processor performance, dynamic scalability, and energy efficiency. In Q4, Intel is helping you deliver greater manageability and security to your business customers, while introducing a new online community to help you improve your server solutions.

### Next-Generation Microarchitecture

Codenamed "Nehalem," this next generation of hafnium-based 45nm Hi-k architecture for server, workstation, desktop, and mobile systems will deliver greater levels of performance with the introduction of new and improved processor technologies. The new Integrated Memory Controller provides the processor direct access to system memory for reduced latency and greater bandwidth. Intel® Smart Cache increases dynamic and efficient allocation of cache across a greater number of cores for fast access to frequently used data. Combined, these technologies create the performance needed for the most demanding multitasking and memory-intensive applications.

### Intel® vPro™ Technology

Next-generation Intel® microarchitecture performance and energy efficiency provide a foundation for Intel® vPro™ technology, helping your business customers manage and protect their IT infrastructure. Notebooks with Intel® Centrino®2 with vPro technology and desktops with Intel® Core™2 processors with vPro technology can help safeguard against data loss and disruption, enabling proactive security and remote manageability even if a system is off or its OS is inoperable. Use your Intel® Channel Partner Program training and technical support benefits to get the most from Intel vPro technology in conjunction with leading business software providers and operating systems.

### Intel® Virtualization Technology

Simpler is better—and hardware-assisted Intel® Virtualization Technology helps your business customers simplify their IT resources by consolidating multiple environments securely in a single server, workstation, or PC. The result is greater flexibility, more applications running on fewer systems, easier management, lower costs, and lower energy usage.

### Intel® Enabled Server Acceleration Alliance (Intel® ESAA)

You could spend time devising your own server solutions through trial and error or you can draw on the experience of your colleagues worldwide, brought together in an online community. The Intel® ESAA program provides resellers free access to interoperable, supported, and validated solution configuration guides based on Intel® technology. Speed your time to market, reduce engineering costs, and align your business with the world's leading server specialists.

### Intel® Atom™ Processors

Built with the world's smallest transistors and manufactured on 45nm Hi-k metal gate technology, Intel® Atom™ processors are a new family of low-power processors. These processors were designed for a range of new market segments, including simple Internet-focused devices such as netbooks and nettops. These devices are ideal for education and government customers as well as consumers who need only simple e-mail, messaging, Web browsing, image viewing, streamed video, and other basic applications.

### Tools to Help You 'Invent the New Reality'

This Product Matrix contains the raw materials to create winning solution recipes for every customer and the ingredients that will truly set you apart in your status as an Intel Channel Partner Program member. Accelerate into 2009 by making the best use of your full channel advantages—from training opportunities to technical support, marketing resources, Intel® Flex+ rewards, and a host of other benefits when you 'buy authorized.'

Thanks for aligning your business with Intel technology-based solutions as an Intel Channel Partner. Going forward, let us know how we can continue delivering the products, programs, and professional support you need to succeed.

**STEVE DALLMAN,  
VICE PRESIDENT AND  
GENERAL MANAGER,  
WORLDWIDE RESELLER  
CHANNEL ORGANIZATION**

**TOM RAMPONE,  
VICE PRESIDENT AND  
GENERAL MANAGER,  
INTEL CHANNEL PLATFORMS GROUP**

Intel, the Intel logo, Intel Atom, Intel Core, Centrino, and Intel vPro are trademarks of Intel Corporation in the U.S. and other countries.

\*Other names and brands may be claimed as the property of others.

Copyright © 2008 Intel Corporation. All rights reserved. 1008/RR/MS Part Number: 317428-005US **October 2008**

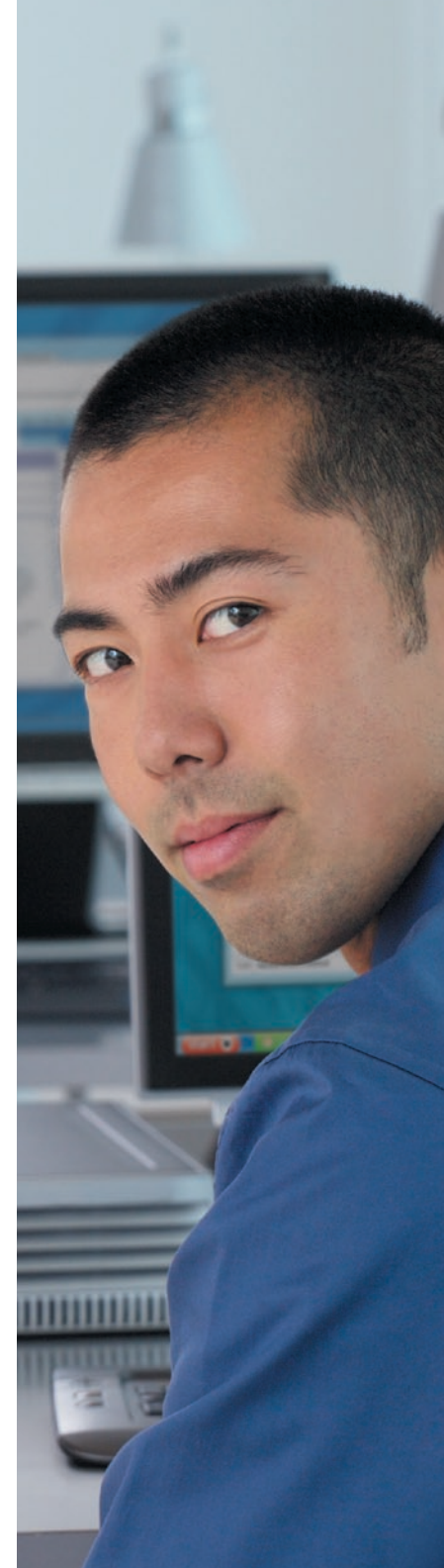



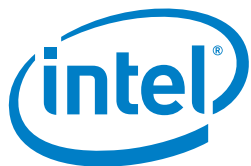

# Next-Generation Intel® Microarchitecture Intel® Core™ i7

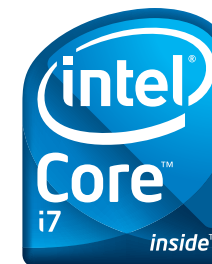
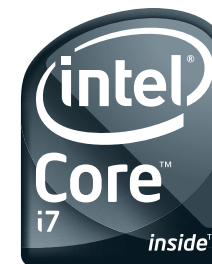

## Optimized for Intel® X58 Express Chipset-based Platforms

FEATURE	BENEFIT
<b>Four cores, eight threads</b>	Exceptional performance and scalability for extreme computing
<b>Intel® Hyper-Threading Technology<sup>1</sup></b>	Simultaneous multi-threading delivers amazing eight-threaded performance—two threads per core
<b>Intel® QuickPath Interconnect (Intel® QPI)</b>	Path to Intel® X58 Express Chipset; up to 25.6 GB/s bandwidth
<b>Intel® Turbo Mode</b>	Delivers an additional processing boost during peak demand
<b>Integrated Memory Controller (IMC)</b>	Three channels of DDR3 at up to 1333 MHz memory frequency for massive bandwidth
<b>Intel® Smart Cache</b>	8 MB cache shared across all four cores

### Three launch frequencies available:

- Intel® Core™ i7-965 processor at 3.2 GHz (Extreme Edition)
- Intel® Core™ i7-940 processor at 2.93 GHz
- Intel® Core™ i7-920 processor at 2.66 GHz

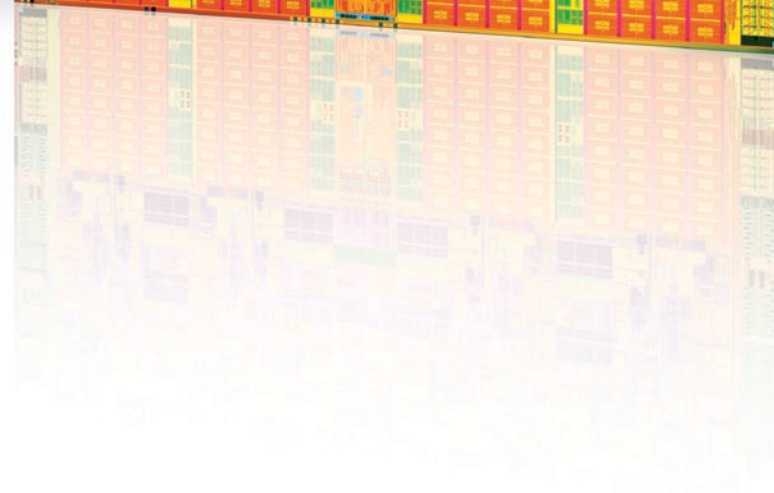

# New Intel® Core™ i7 Processor-based Consumer Desktop Platform

## Benefits for OEM and Channel System Builders

### Industry-Leading Processor Performance<sup>2</sup>

- Exceptional performance and scalability for extreme computing
- Intel® Hyper-Threading Technology<sup>1</sup> delivers eight-threaded performance capability on four cores
- Intel® Turbo Mode delivers an additional processing boost during peak demand

### Unprecedented Bandwidth

- Integrated Memory Controller with up to three channels of DDR3 1333 MHz—two DIMMs per channel—offers memory performance of up to 32 GB/s
- Intel® X58 Express Chipset with Intel® QuickPath Interconnect (Intel® QPI) connects to the processor for 25.6 GB/s maximum peak bandwidth

### Graphics Flexibility

- All vendor single graphics card options are supported
- Intel extends multi-card configuration options—two x16 or four x8 PCI Express\* 2.0 Graphics connectors

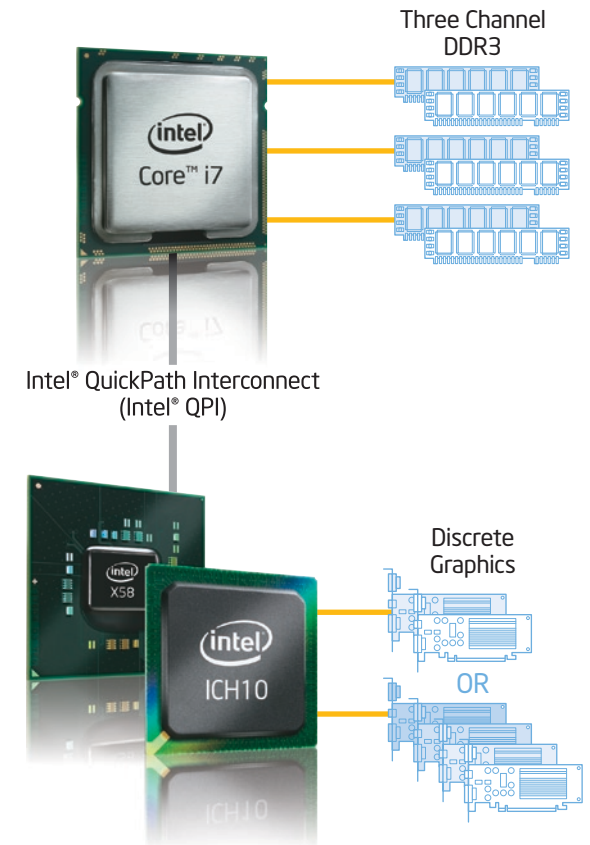

# Intel® Desktop Boards DX58SO and DX48BT2

Same ATX Form Factor!

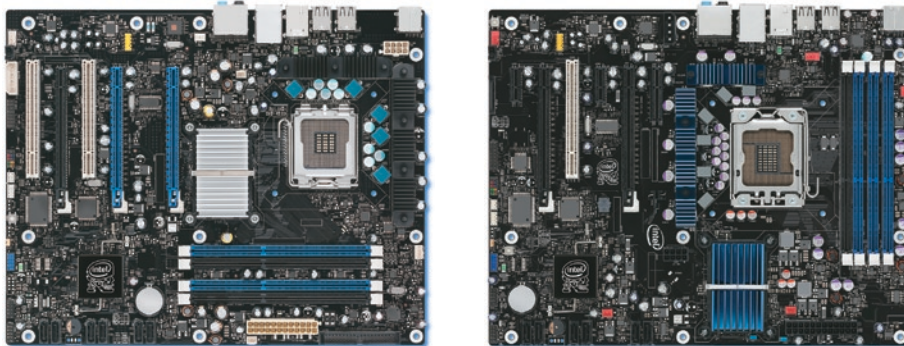

## What are the Feature Differences?

Intel® Desktop Board DX48BT2	Intel® Desktop Board DX58SO
Intel® Core™2 Extreme and Intel® Core™2 Quad Processors in the LGA775 Package	Intel® Core™ i7 Processors in the LGA1366 Package
Four cores, four threads	Four cores, eight threads
Not available	Intel® Hyper-Threading Technology <sup>1</sup>
Two channels DDR3 Memory	Three channels DDR3 Memory <sup>3</sup>
Front Side Bus	Intel® QuickPath Interconnect

## Mind-Blowing Platform Performance with the Intel® Desktop Board DX58SO and the Intel® Core™ i7 Processor

- Four cores with eight processing threads
- Exceptional performance and scalability for extreme computing
- Intel® Hyper-Threading Technology<sup>1</sup> delivers amazing eight-threaded performance—two threads per core
- Intel® Turbo Mode delivers an additional processing boost during peak demand

## Groundbreaking Bandwidth Speeds for Your Data

- Integrated Memory Controller with three channels of DDR3 1333 MHz offers memory performance of up to 32 GB/s
- Intel® X58 Express Chipset with Intel® QuickPath Interconnect (Intel® QPI) connects to the processor for 25.6 GB/s maximum peak bandwidth

## Graphics Powerhouse

- All vendor single graphics card options are supported
- The Intel® Desktop Board DX58SO has two full-speed PCI Express\* 2.0 x16 slots for maximum bandwidth for dual-card ATI\* CrossFire\*

<sup>1</sup> Hyper-Threading Technology requires a computer system with a processor supporting HT Technology and an HT Technology-enabled chipset, BIOS, and operating system. Performance will vary depending on the specific hardware and software you use. For more information including details on which processors support HT Technology, see [www.intel.com/info/hyperthreading](http://www.intel.com/info/hyperthreading).

<sup>2</sup> Compared to prior generation equally spec'd components.

<sup>3</sup> Memory control moves to the processor with additional channel of DDR3 added: Integrated Memory Controller (IMC) with three channels of DDR3, two DIMMs per channel; up to 32 GB/s memory bandwidth at DDR3 1333 MHz.

\* Other names and brands may be claimed as the property of others.

Intel, the Intel logo, Intel Core, and Core Inside are trademarks of Intel Corporation in the U.S. and other countries.  
Copyright © 2008 Intel Corporation. All rights reserved. 1008/RR/MS Part Number: 308239-013US October 2008





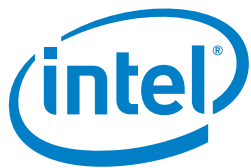

# Intel® Modular Server

## Built on Intel® Multi-Flex Technology

### Simple. Flexible. Exceptional Value.

In a confusing world of features and specifications, your customers may ask, "So what? How can this product help me solve my IT needs?"

The Intel® Modular Server is an integrated system built on Intel® Multi-Flex Technology that includes SAN storage, computing, and networking to simplify the growing demands of your IT infrastructure. The Intel Modular Server features:

- Up to six Server Compute Modules
- Integrated SAN storage
- Integrated Ethernet Switch Modules
- All hot-swappable components
- Virtual Presence remote management capabilities

As an integrated system, the Intel Modular Server has capabilities not found in the common rack server setup, including virtual drives that provide grow-as-you-go flexibility and Virtual Presence management for simplicity.



### The Intel® Modular Server provides a solution with practical, day-to-day benefits.

BENEFIT	ENABLER
<b>Increased IT Uptime</b>	Redundant systems increase network uptime with failovers between servers and backups.
<b>Easy Application Migration</b>	Shared storage and virtual drives provide easy application and storage migration.
<b>Grow-As-You-Go Flexibility</b>	With options for up to 6 Server Compute Modules and up to 14 storage drives or 6 3.5" drives, purchase only as much as you need when you need it.
<b>Greater Asset Utilization</b>	Diskless Server Compute Modules allow for maximum use of system assets.
<b>Unique Serviceability</b>	Hot-swappable components don't require any cables or tools to service.
<b>Ease of Management</b>	One integrated system with end-to-end management lets you manage the entire system from a Web-based GUI interface.
<b>Improved Data Protection</b>	Centralized backup and virtual access allow for greater data protection.

QUALIFYING THE CUSTOMER	TARGET CUSTOMER PROFILE
How many servers do they plan to purchase?	Plans to purchase 2-3 servers this year.
How many end users does their IT infrastructure support?	Has a network that supports 50-500 employees.
Would they like to simplify their networking management needs?	Wants a network switch that is easy to deploy, configure, and maintain.
Are they interested in redundant systems to improve server uptime?	Needs greater application uptime with planned recovery options.
Are they interested in integrating their networking needs to free up valuable IT time?	Has an IT technician who has other responsibilities besides managing the network.
Do they want high-end capabilities without going beyond their budget?	Needs their IT to be as flexible as their company is while staying within budget.



## Why should you care?

Intel® Server Products offer best-in-class service and support. What does that mean for you as a server reseller?

- Expand revenue opportunities with software upgrades, storage solutions, and service agreements.
- Achieve ease of integration and management with single management applications for servers, clients, and networks.
- Provide industry-leading performance while others follow.

For the small to midsize business, it isn't about what technology they can purchase—it's about solutions for their IT concerns.

**Challenge** We have four servers running e-mail, Web, accounting, and database applications. Lately, we've been short on storage space. The accounting server has just the right amount of storage, but the mail server is short, and the Web server has significantly more than it needs. When we purchased the servers, our options were limited by the number of disks that the servers could hold, as well as the minimum number required to create RAID 5 disk sets.

**Scenario** Four rack-based 2U servers that are three years old, each with four SCSI disk RAID 5 sets. The mail server needs more space, but we have already reached internal capacity. The Web server load has increased significantly and requires a more robust server.

**Solution** Upgrade to the Intel® Modular Server with four Server Compute Modules—one for each of these applications—and a stand-by server. The Intel Modular Server can provide level 5 RAID access for five servers with as few as three drives. Increasing storage space is as easy as adding drives and expanding the storage pool through the simple Web management interface. As new compute technology becomes available, upgrading a server will be a matter of sliding out the old server and inserting the new one. With server failover capabilities, major downtime due to server failures will be a thing of the past.



## Total Cost of Ownership

### Flexible

- With integrated shared storage and options for up to six servers, buy only the storage and computing capacity you need—and add more later as required.

### No Rewiring

- Chassis power supplies can utilize 100–240 V power, eliminating special power requirements worldwide.

### Built for Future Generations

- The chassis has been designed to support multiple generations of Server Compute Modules, allowing swift upgrades to the latest computing technology and increasing the longevity of the chassis.

# Intel® Modular Server

## Built on Intel® Multi-Flex Technology

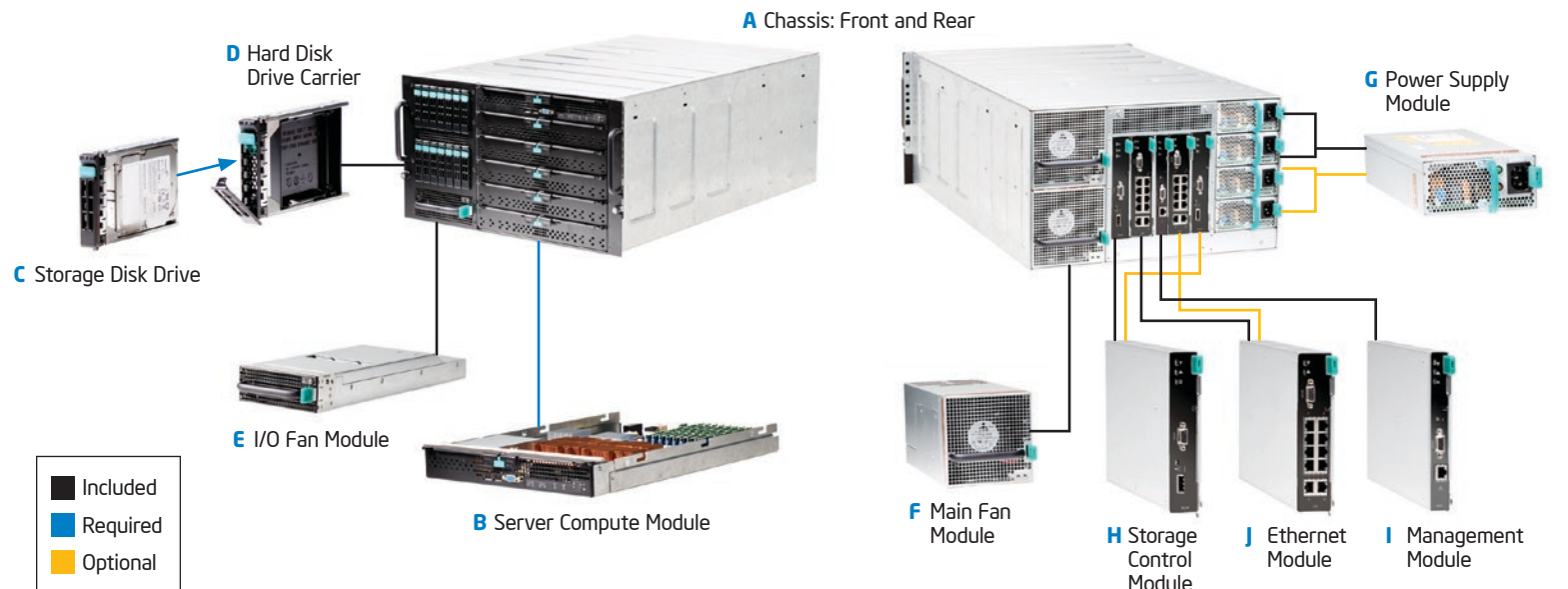

### A Chassis

- 1-6 Server Compute Modules
- Storage Drive Bay

### B Server Compute Module (required)

- Model MFS5000SI
- Up to 2 Multi-Core Intel® Xeon® processors
- Contains 8 FBDIMM slots for up to 32 GB
- Supports an optional Mezzanine expansion card

### C Storage Hard Disk Drive (required)

- Up to 14 2.5" SAS drives
- Up to 6 3.5" SAS/SATA drives

### D Hard Disk Drive Carriers (included)

### E Hot-Swappable I/O Fan Module (included)

### F Hot-Swappable Main Fan Module (included)

### G Hot-Swappable Power Supply Module

- (2 included, 2 optional)
- 3 + 1 redundancy

### H Storage Control Module

- (1 included, 1 optional)
- Up to 2 Storage Control Modules for redundancy

### I Management Module (included)

### J Ethernet Switch Module

- (1 included, 1 optional)
- Up to 2 Ethernet Switch Modules
- Each module features 10/100/1000GbE full-duplex ports

For more information on the Intel® Modular Server and Intel® Multi-Flex Technology, visit [www.intel.com/go/mft](http://www.intel.com/go/mft)

\*Other names and brands may be claimed as the property of others.

Intel, the Intel logo, and Xeon are trademarks of Intel Corporation in the U.S. and other countries.

Copyright © 2008 Intel Corporation. All rights reserved. 1008/RR/MS Part Number: 318715-004US October 2008

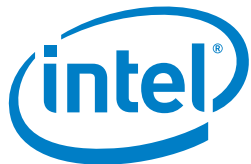

# Intel® vPro™ Processor Technology

Security and manageability on the chip.

**Increase security and simplify management of desktop PCs with the hardware-assisted capabilities of Intel® vPro™ processor technology. Proactively secure desktops and improve manageability. Upgrade to the energy-efficient, dual-core performance of the latest Intel® Core™2 Duo processor. Now, with Intel vPro processor technology, you can help your customers shift resources from managing PCs to strategic initiatives that accelerate business success.**

Why should you sell Intel® vPro™ processor technology business PCs?

- **It is easier to position and sell**  
Tell your customers about the clear advantages it has for businesses: advanced security and manageability features on the chip, powerful performance, cost effectiveness, and reliability.
- **It helps promote higher profits**  
Allows you to offer high-margin integration and managed support services for Intel vPro processor technology-based solutions.
- **It helps drive more sales**  
Leverage Intel vPro processor technology-based products as part of extended computing solutions and sell more servers, networking equipment, and software.
- **It helps generate more repeat business**  
Highlight the reliability, security, and manageability features of Intel vPro processor technology to help bring customers back for more technology purchases.
- **It helps transform your business into a true solution provider**  
More easily build and offer integrated (HW/SW/service) solutions addressing the needs of your business customers.

For more information about Intel vPro processor technology and solutions, visit:

[www.intel.com/reseller/vpro](http://www.intel.com/reseller/vpro)  
[www.intel.com/go/vpro](http://www.intel.com/go/vpro)  
<http://msp.intel.com>



## Finding the Right Fit

One of the most costly aspects for small and midsize business—in terms of money, resources, and productivity—is managing PCs, servers, and software on the network. Many critical IT tasks, such as patches, updates, and daily maintenance, must be performed during work hours when they interrupt employees or cause downtime. At the same time, you need to physically visit PCs and servers when systems cannot be located, diagnosed, repaired, or remediated down the wire. **Intel® System Management Solution** is specifically designed for IT professionals in small to midsize businesses who often face IT challenges similar to those of larger enterprises—troubleshooting end-user problems, automating management tasks, managing multiple systems, and diagnosing and resolving IT problems—but who don't have the luxury of a full staff of specialists.

## PCs with Intel® Centrino® with vPro™ technology Solution Spotlight: Intel® Centrino® with vPro™ technology with Intel® System Management Software with Microsoft\* System Center Essentials 2007

### IT infrastructure management for small to midsized businesses (SMB)

Intel® System Management Software with Microsoft\* System Center Essentials 2007 not only manages Intel® vPro™ processor technology clients, it also manages servers, operating systems, applications, network devices—essentially the whole network.

**Business challenge: SMB customers need an easy-to-use, low-maintenance, and affordable solution for keeping their entire IT infrastructure healthy and running smoothly from a single console.**

SMBs cannot afford to hire the entire range of skill sets they need to manage their IT infrastructure—but they still need reliable, healthy computing environments. Some of the challenges SMBs face include:

- Software and security updates to provide patch management and validation of patch deployment.
- Threat containment to isolate PCs using filters, and send alerts based on hardware event logs.
- System health monitoring to provide critical information about hardware via non-volatile memory and server-based hardware sensors (for temperature issues)—even when the PC is powered off.
- Remote system diagnosis and repair to access hardware asset information and remotely watch to identify problems such as BIOS, drivers, and OS load.
- Patch, OS, and application deployment to verify that patches or applications are deployed and installed successfully, and to run an inventory to determine system readiness.
- Remote asset tracking, audit collection services, and software compliance to inventory software and files on PCs—even if the PC is off.

- Remote power management to ready PCs for employees and to power down PCs after business hours to save energy.

### About Intel® System Management Software with Microsoft\* System Center Essentials 2007

Intel System Management Software with Microsoft System Center Essentials 2007 includes a series of network management applications that allow you to view and control aspects of your computing environment from a single location and one interface. Depending on your existing setup, you may already have some of the system components in place, so you don't have to buy an entirely new set of components—it's about making your system work for you today!

Intel System Management Software consists of the following components:

- **Microsoft\* System Center Essentials 2007**  
Built specifically with small to midsize businesses in mind, Microsoft System Center Essentials 2007 provides a proactive and unified management solution that helps enable you to more efficiently secure, update, monitor, and troubleshoot your IT environments.
- **Intel® System Management Software 3.0**  
Intel System Management Software 3.0 includes a custom installer that simplifies the installation of Microsoft System Center Essentials 2007 and the Intel-developed management packs.
  - Intel® Server Management Pack
  - Intel® Modular Server Management Pack
  - Intel® Active Management Technology (Intel® AMT)<sup>1</sup> Management Pack

These management packs allow Microsoft System Center Essentials 2007 to take advantage of the unique built-in manageability benefits of servers using Intel® Xeon® processor-based server systems and PCs with

### Intel and Microsoft—A Perfect Match

Co-developed by Intel and Microsoft, Intel® System Management Software with Microsoft\* System Center Essentials 2007 is designed specifically for small and midsize businesses who often face IT challenges similar to those of larger enterprises. By using this solution, you can streamline tasks, keep servers and PCs up-to-date, and help boost security, compliance, and uptime.

#### ▪ Simple

Streamlines your IT management tasks through the life cycle of both servers and PCs—simplifying with one suite of tools that contain built-in expertise.

#### ▪ Secure

Accurately identifies and keeps your servers and PCs up-to-date with the latest BIOS, firmware, and patches; enables Microsoft System Center Essentials 2007 to take advantage of the unique built-in manageability benefits of servers with Intel® Xeon® processor-based server boards and PCs with Intel® Centrino® with vPro™ technology.

#### ▪ Smart

Specifically targeted for small and midsize businesses to increase your efficiency, reduce costs, and boost security features, compliance, and uptime.

Intel® Centrino® with vPro technology, and allow you to manage these systems regardless of Microsoft Windows\* availability or power state. If you have PCs with Intel Centrino with vPro technology, you can access various levels of remote configuration, from manual to fully automated. When PCs are managed with Microsoft System Center Essentials 2007, these new hardware-based capabilities can help speed up many processes, increase automation, and significantly reduce service costs across the infrastructure.

# Intel® Centrino® with vPro™ technology with Intel® System Management Software with Microsoft\* System Center Essentials 2007

More than just a dashboard with data, Microsoft\* System Center Essentials 2007 provides expert knowledge for problem solving and tools for streamlining daily activities. Reports and tips help your customers efficiently maintain network health and security.

## Simple.

### Patch, OS, and Application Deployment

#### FEATURES:

- Include templates and wizards to simplify the deployment process
- Schedule deployments for non-peak hours
- Run inventory checks to determine environment readiness for Microsoft Windows Vista\* and Microsoft\* Office 2007

#### BENEFITS:

- Minimize disruption to employees
- Update PCs even if they are turned off
- Verify if software is installed correctly

### Remote Asset Tracking, Audit Collection Services, and Software Compliance

#### FEATURES:

- Enable more secure console redirection to remotely troubleshoot PCs, even if the OS is unresponsive or hardware has failed
- Redirect PC's boot device to another device, such as a remediation drive
- Make it possible to remotely watch as BIOS, drivers, and OS load to identify problems

#### BENEFITS:

- Eliminate most desk-side or server visits traditionally required to resolve OS problems and diagnose hardware failures
- Eliminate employee participation in diagnostics and repair processes
- Increase accuracy of remote diagnostics for software and hardware problems

## Secure.

### Software and Security Updates

#### FEATURES:

- Provide encrypted, more secure remote power up of PCs so they can receive critical patches or updates
- Let you automatically subscribe to security patches
- Include patch management and validation of patch deployment

#### BENEFITS:

- Eliminate virtually all manual updates
- Reduce windows of vulnerability
- Speed up security updates, patches, application, and OS deployment

### Threat Containment

#### FEATURES:

- Enable proactive health monitoring of network traffic so you can take pre-specified actions
- With Intel® AMT<sup>1</sup> Management Pack, you can isolate PCs via a preset hardware-based filter
- With Intel® Server Management Pack, the system can send alerts based on hardware event logs

#### BENEFITS:

- Receive alerts when problems arise
- Minimize the impact of a security threat in the computing environment
- Mitigate attacks by removing hardware from the network, tracking the issues in log files, and closing ports or access to certain sites

## Smart.

### Secure, Remote Power Up/Power Cycle and Power Management

#### FEATURES:

- Secure, remote power up of a PC for maintenance or other remote or off-hours service
- Power down PC off-hours to save energy

#### BENEFITS:

- Automate off-hours maintenance even for PCs that are powered off
- Reduce power bills

### System Health Monitoring

#### FEATURES:

- Drill-down to specific hardware and software components in your environment
- Get critical information about the hardware in your environment
- Easy to navigate and use

#### BENEFITS:

- Proactively predict hardware and software failures
- More efficiently use IT resources

### Remote System Diagnosis and Repair

#### FEATURES:

- Use secure console redirection to remotely troubleshoot PCs, even if the OS is unresponsive or hardware has failed
- Access hardware asset information and persistent event log anytime

#### BENEFITS:

- Eliminate most desk-side or server visits traditionally required to resolve OS problems or diagnose hardware failures
- Increase accuracy of remote diagnostics for software and hardware problems

## Summary

Addressing the IT challenges of small and midsize businesses, Intel and Microsoft have come together to provide you with a comprehensive, easy-to-use solution for managing your complete IT environment. Intel® System Management Software with Microsoft\* System Center Essentials 2007 helps improve security, speeds up problem solving, and lowers your service costs. Depending on your existing setup, you may already have some of the system components, so why not get started today? Contact your local Intel or Microsoft dealer for more information. The Microsoft System Center Essential 2007—Single Server Edition is shipped for free on most Intel® Server Boards and System and can be upgraded to Small Network or Standard Edition by simply entering a license key.

### Small Business versions (Single Server and Small Network)

Available from Intel and Intel distributors only, and designed especially for small businesses.

### Want to give it a try?

You can access an online demo or download a 90-day trial version at:

[www.microsoft.com/systemcenter/essentials](http://www.microsoft.com/systemcenter/essentials)

For more information about Intel® System Management Solution, visit [www.intel.com/go/servermanagement](http://www.intel.com/go/servermanagement) or contact your local authorized Intel dealer.

For more information about PCs with Intel® Centrino® with vPro™ technology, visit [www.intel.com/go/businesspc](http://www.intel.com/go/businesspc)

For more information about Microsoft\* System Center Essentials 2007, visit [www.microsoft.com/systemcenter/essentials](http://www.microsoft.com/systemcenter/essentials) or contact your local Microsoft reseller.

### Intel® System Management Software with Microsoft\* System Center Essentials 2007

The Intel® System Management Solution is offered in three different configurations. The Single Server Edition is included with select Intel® Xeon® processor-based server boards and integrated server products from Intel.

	Small Business Market		Mid-Market
	Single Server Edition	Small Network Edition	Standard Edition
MSRP	Free <sup>2</sup>	\$599.00 USD	\$1999.00 USD
Number of Servers Supported	1	Up to 5	Up to 30 <sup>3</sup>
Number of Clients (PCs) Supported	0	15	Up to 500 <sup>3</sup>
Client Access License (CAL)	\$100 USD/ Server and \$20 USD/client	\$100 USD/ Server and \$20 USD/client	\$100 USD/ Server and \$20 USD/client
Availability	Intel authorized dealers	Intel authorized dealers	Intel and Microsoft authorized dealers

<sup>1</sup> Intel® Active Management Technology (Intel® AMT) requires the platform to have an Intel AMT-enabled chipset, network hardware, and software, as well as connection with a power source and a corporate network connection. Setup of Intel AMT requires configuration by the purchaser and may require scripting with the management console or further integration into existing security frameworks to enable certain functionality. It may also require modifications or implementation of new business processes. With regards to notebooks, Intel AMT may not be available or certain capabilities may be limited over a host OS-based VPN or when connecting wirelessly, on battery power, sleeping, hibernating, or powered off. For more information, see [www.intel.com/technology/platform-technology/intel-amt/](http://www.intel.com/technology/platform-technology/intel-amt/).

<sup>2</sup> Included with select server boards or systems.

<sup>3</sup> Additional Client Access Licenses (CAL) may be required.

Features and Functions of Microsoft\* System Center Essentials 2007 and the Intel® Management Packs are dependent on the features and functions available on the server and client hardware and the loaded software and operating systems. Not all features and functions are available on all products and may require Intel® AMT or IPMI technologies for additional functionality. Intel, the Intel logo, Intel Core, Core Inside, Xeon, Intel vPro, Intel vPro Inside, and Centrino are trademarks of Intel Corporation in the U.S. and other countries.





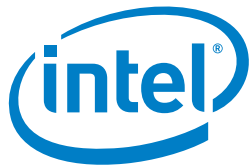













\*Other names and brands may be claimed as the property of others.

Copyright © 2008 Intel Corporation. All rights reserved. 1008/RR/MS Part Number: 317978-005US October 2008













# Better Together: Recommend the Best Intel® Processor and Intel® Desktop Board for Your Consumer Customer

## Desktop Consumer Matrix

USAGE	RECOMMENDED INTEL® PROCESSORS <sup>1</sup>	RECOMMENDED INTEL® DESKTOP BOARDS	SELL-TO MESSAGE	NO. OF CORES / THREADS	MAX. FREQ. <sup>2</sup>	MAX. FRONT SIDE BUS	CACHE <sup>3</sup>
 <b>Extreme Gaming</b>	 <b>Intel® Core™ i7 Extreme Edition</b>	 <b>DX5850</b>	Customer is looking for unrivaled competitive gaming and/or media performance.	<b>4/8</b>	3.20 GHz	1333 MHz	8 MB L3 shared
 <b>Gaming and HD</b>	 <b>Intel® Core™ i7</b>	 <b>DG45ID/DG45FC</b>	Customer enjoys visually intense gaming and/or high-definition media.	<b>4/8</b>	2.93 GHz	1066 MHz	8 MB L3 shared
 <b>Everyday Performance</b>	 <b>E8000/E7000/E6000 series</b>	 <b>DG43NB/DG43TF</b>	Customer creates and stores photos, videos, and music on their PC.	<b>2/2</b>	3.33 GHz	1333 MHz	6 MB L2 shared
 <b>Simple Multitasking</b>	 <b>E5000/E2000 series</b>	 <b>DG41TY</b>	Customer wants a PC for a variety of simple tasks.	<b>2/2</b>	2.50 GHz	800 MHz	2 MB L2 shared
 <b>Just the Basics</b>	 <b>E1000 series</b>	 <b>D945GCPE</b>	Customer just wants a basic dual-core PC at our lowest price point.	<b>2/2</b>	2.20 GHz	800 MHz	512 KB L2
<b>INTRODUCING THE INTEL® ATOM™ PROCESSOR FOR NETTOPS</b>							
 <b>Internet Centric</b>	 <b>300 series</b>	 <b>D945GCLF2</b>	Customer is looking for an affordable secondary device to access the Internet in the home.	<b>2/4</b>	1.60 GHz	533 MHz	1 MB L2

# Better Together: Recommend the Best Intel® Processor and Intel® Desktop Board for Your Business Customer

## Desktop Business Matrix

FOR USER TYPE	CURRENT / FUTURE USAGE	BENEFITS	RECOMMENDED INTEL® PROCESSORS <sup>1</sup>	NO. OF CORES	MAX. FREQ <sup>2</sup>	MAX. FRONT SIDE BUS	CACHE <sup>3</sup>	PROOF POINTS	RECOMMENDED INTEL® DESKTOP BOARDS
<b>Professional</b>	<ul style="list-style-type: none"> <li>Software patch deployment</li> <li>Advanced diagnostics and repair</li> <li>High-impact business productivity</li> </ul>	<ul style="list-style-type: none"> <li>Enables the Managed Service Provider to provide professional 24x7 technical support for much less than what it would cost you to hire more full-time staff</li> <li>Securely and remotely wake up, update, and shut down systems, even if the PC is off</li> <li>Adds more protection against viruses and malicious attacks with programmable system defense filters</li> </ul>	 <b>E8000</b> series	<b>2</b>	3.33 GHz	1333 MHz	6 MB L2 shared	<ul style="list-style-type: none"> <li>Helps ensure more accurate automatic hardware asset inventory</li> <li>Reduces the need for hardware-related desk-side visits</li> <li>Approximately 150% faster running typical office productivity benchmarks<sup>4</sup></li> </ul>	 <b>DQ45CB/DQ45EK</b>
<b>Power</b>	<ul style="list-style-type: none"> <li>Professional content development</li> <li>Advanced modeling and simulations</li> <li>Building powerful Internet applications</li> </ul>	<ul style="list-style-type: none"> <li>Industry-leading performance for Windows Vista®, 64-bit applications, and next-generation software</li> <li>Great graphics, excellent for the Vista Aero® graphics interface</li> </ul>	 <b>Q9000/Q6000</b> series	<b>4</b>	3 GHz	1333 MHz	12 MB L2 shared	<ul style="list-style-type: none"> <li>Up to 2.75x faster on office productivity benchmarks compared to previous-generation installed base<sup>5</sup></li> <li>Up to 9x faster on advanced Microsoft Excel® calculations compared to previous-generation installed base<sup>5</sup></li> </ul>	 <b>DQ45CB/DQ45EK</b>
<b>Advanced</b>	<ul style="list-style-type: none"> <li>Cross-functional / boundary productivity and collaboration</li> <li>Advanced content development</li> <li>Anti-virus / spam, spyware, and data backup</li> </ul>	<ul style="list-style-type: none"> <li>Industry-leading performance with improved graphics performance</li> <li>Improved energy efficiency without sacrificing performance</li> </ul>	 <b>E8000</b> series	<b>2</b>	3.33 GHz	1333 MHz	6 MB L2 shared	<ul style="list-style-type: none"> <li>Over 90% faster when multitasking than prior-generation products<sup>6</sup></li> <li>Over 90% faster performance on compute-intensive applications than prior-generation products<sup>6</sup></li> </ul>	 <b>DG43NB/DP43TF</b>
<b>Evolving</b>	<ul style="list-style-type: none"> <li>Cross-functional productivity</li> <li>Streamlining business process</li> <li>Communications</li> <li>Anti-virus and data backup</li> <li>VoIP</li> </ul>	<ul style="list-style-type: none"> <li>Protection from viruses and data loss</li> <li>Multitasking responsiveness</li> <li>Quality VoIP</li> </ul>	 <b>E7000</b> series	<b>2</b>	2.80 GHz	1066 MHz	3 MB L2 shared	<ul style="list-style-type: none"> <li>62% faster image content video encoding than prior-generation products<sup>6</sup></li> <li>17% faster productivity benchmark than prior-generation products<sup>6</sup></li> </ul>	 <b>DG43NB/DP43TF</b>
<b>Basic</b>	<ul style="list-style-type: none"> <li>Personal productivity</li> <li>Core content creation</li> <li>Essential communication</li> <li>Basic anti-virus</li> </ul>	<ul style="list-style-type: none"> <li>Protection from viruses</li> <li>Value and reliability</li> </ul>	 <b>E5000</b> series	<b>2</b>	2.50 GHz	800 MHz	2 MB L2 shared	<ul style="list-style-type: none"> <li>28% faster spreadsheets than prior-generation products<sup>7</sup></li> <li>27% faster productivity benchmark than competition<sup>8</sup></li> </ul>	 <b>DG41TY</b>

<sup>1</sup> Intel processor numbers are not a measure of performance. Processor numbers differentiate features within each processor family, not across different processor families. See [www.intel.com/products/processor\\_number/](http://www.intel.com/products/processor_number/) for details.

<sup>2</sup> Processor frequency as shown represents maximum frequency specification for the respective processor number family.

<sup>3</sup> Intel® Core™2 Duo and Core™2 Quad processors employ Intel® Advanced Smart Cache.

<sup>4</sup> (Desktop) Pre-production Intel® Core™2 Duo Processor E8200 (6 MB L2, 2.66 GHz, 1333 MHz FSB) and Pre-Production Intel® Core™2 Quad Processor Q9450 (6 MBx2 L2, 2.66 GHz, 1333 MHz FSB) on Intel® Desktop Board DQ35JOE, Intel® Chipset Software Installation File 8.30.1013, 2x1 GB dual-channel Micron® PC2-6400 DDR2 800 5-5-5-15, Intel® Pentium®4 Processor 530 (1 MB L2, 3.00 GHz, 800 MHz FSB) on Intel® Desktop Board D945GCL, Intel® GMA950 Express Chipset, Intel® Chipset Software Installation File 8.1.1.1010, 2x1 GB dual-channel Micron® PC2-6400 DDR2 667 5-5-5-15. Common to all platforms: Seagate® 320 GB Barracuda 7200.10 NCQ Serial ATA 7200 RPM, Windows Vista® Ultimate 32bit. Performance tests and ratings are measured using specific computer systems and/or components and reflect the approximate performance of Intel products as measured by those tests. (Mobile) Based on measured Intel® Pentium® M 780 (2 MB L2, 2.26 GHz, 533 MHz FSB) and estimated Intel® Pentium® M 770 (2 MB L2, 2.13 GHz, 533 MHz FSB) versus Pre-Production Mobile Intel® Core™2 Duo Processor T8100 (3 MB L2, 2.10 GHz, 800 MHz FSB ) on Intel® Matanzas Customer Reference Board, Intel® Chipset Software Installation File 8.2.0.012, 2x1 GB dual-channel Micron® PC2-5300 DDR2 800 5-5-5-15, Hitachi® 100 GB TravelStar® Serial ATA 7200 RPM, Windows Vista Ultimate 32bit.

<sup>5</sup> (Desktop) Pre-production Intel® Core™2 Duo Processor E8200 (6 MB L2, 2.66 GHz, 1333 MHz FSB) and Pre-Production Intel® Core™2 Quad Processor Q9450 (6 MBx2 L2, 2.66 GHz, 1333 MHz FSB) on Intel® Desktop Board DQ35JOE, Intel® Chipset Software Installation File 8.30.1013, 2x1 GB dual-channel Micron® PC2-6400 DDR2 800 5-5-5-15, Intel® Pentium® 4 Processor 530 (1 MB L2, 3.00 GHz, 800 MHz FSB) on Intel® Desktop Board D945GCL, Intel® GMA950 Express Chipset, Intel® Chipset Software Installation File 8.1.1.1010, 2x1 GB dual-channel Micron® PC2-6400 DDR2 667 5-5-5-15. Common to all platforms: Seagate® 320 GB Barracuda 7200.10 NCQ Serial ATA 7200 RPM, Windows Vista® Ultimate 32bit.

<sup>6</sup> Source: Intel. Configuration: Intel® Core™2 Duo E8200 (2.66 GHz, 6 MB L2, 1333 MHz FSB), E7200 (2.53 GHz, 3 MB L2, 1066 MHz FSB), E4600 (2.40 GHz, 2 MB L2, 800 MHz FSB) on Intel® Desktop Board DQ35JO with Intel® Graphics Media Accelerator 3100 onboard graphics subsystem, Intel® Chipset INF 8.4.0.1016, 2x512 MB dual-channel Micron® DDR2-667 5-5-5-18, Seagate® 320 GB Barracuda® NCQ Serial ATA 7200 RPM, Windows Vista® Ultimate 32bit.

<sup>7</sup> Intel® Pentium® D processor 925 (3 GHz, 800 MHz FSB, 2x2 MB L2 Cache), Intel® Pentium® Dual-Core processor E2160 (1.80 GHz, 800 MHz FSB, 1 MB L2 Cache) and both with Intel® Desktop Board D946GZIS, Intel® Graphics Media Accelerator 950, Chipset Install file 8.1.1.1010, Micron® 2x512 MB DDR2 667 5-5-5-15, Seagate® Barracuda® 320 GB NCQ SATA2 7200RPM, Windows Vista® Ultimate RTM Build 6000 NTFS, AMD® Athlon® 64 X2 3800+ (2 GHz, 2x512 KB L2 Cache), Asus® M2A-VM, Integrated ATI® X1200 Series, Micron 2x512 MB DDR2 667 5-5-5-15, Seagate Barracuda 320 GB NCQ SATA2 7200RPM, Windows Vista Ultimate RTM Build 6000 NTFS. Run description: Microsoft Excel® 2007 executing approximately 28,000 sets of calculations using common calculations and functions.

<sup>8</sup> Source: Intel. Configurations: Intel® Core™2 Duo processor E6700 (2.66 GHz, 4 MB shared L2, 1066 MHz FSB), Intel® Core™2 Duo processor E6420 (2.13 GHz, 4 MB shared L2, 1066 MHz FSB), Intel® Core™2 Duo processor E4400 (2.0 GHz, 2 MB shared L2, 800 MHz FSB), Intel® Core™2 Duo processor E4300 (1.80 GHz, 2 MB shared L2, 800 MHz FSB), Intel® Pentium® dual-core processor E2160 (1.80 GHz, 1 MB shared L2, 800 MHz FSB), Intel® Pentium® D processor 945 (3.40 GHz, 2x2 MB total L2, 800 MHz FSB), Intel® Pentium® D processor 925 (3 GHz, 2x2 MB total L2, 800 MHz FSB). Processors as listed above. Intel: (for Conroe-based parts) Intel® Q965 Express Chipset, Intel® Desktop Board DQ965GF, Chipset Install file 8.1.1.1010, BIOS version C096510J.86A.5882, Intel® GMA 3000 graphics, Graphics Driver: Intel® G965 15.2.3.1244 , Micron® 2x1 GB DDR2-667 5-5-5-15, Seagate® Barracuda® 320 GB SATA 7200 RPM, Hard Disk Driver: Intel® Matrix Storage driver 6.2.1.1002\_PV, Windows Vista® x86 Ultimate RTM build 6000 (for Netburst based parts) Intel® GMA 950 Express Chipset, Intel® Desktop Board D945GPM, Chipset Install File 8.1.1.1010, BIOS version NT94510J.86A.4076 Intel GMA 3000 graphics, Graphics Driver: Intel G965 15.2.3.1244 , Micron 2x1 GB DDR2-667 5-5-5-15, Seagate Barracuda 320 GB SATA 7200 RPM, Hard Disk Driver: Intel® INF 8.1.1.1010, Windows Vista x86 Ultimate RTM build 6000, Enhanced Intel SpeedStep® Technology disabled. AMD: AMD® Athlon® 64 X2 6000+ (3 GHz, 2x1 MB L2), AMD® Athlon® 64 X2 4200+ (2.20 GHz, 2x512 KB L2), AMD® Athlon® 64 X2 3800+ (2 GHz, 2x512 KB L2), ATI® RS690G, ASUS® M2A-VM, Chipset Install File ATI® Catalyst® 7.4, BIOS Asus® M2A-VM 402, ATI® Radeon® Express 1250, Graphics driver ATI Catalyst 7.4, Micron 2x1 GB DDR2-667 5-5-5-15, Seagate Barracuda 320 GB SATA 7200 RPM Hard Disk Driver: ATI Catalyst 7.4, Windows Vista® Ultimate 32 RTM build 6000, AMD® Cool n' Quiet disabled. Test: SysMark®07.

Performance tests and ratings are measured using specific computer systems and/or components, and reflect the approximate performance of Intel products as measured by those tests. Any difference in system hardware or software design or configuration may affect actual performance. Buyers should consult other sources of information to evaluate the performance of systems or components they are considering purchasing. For more information on performance tests and on the performance of Intel products, visit [www.intel.com/performance/](http://www.intel.com/performance/) or call (U.S.) 1-800-628-8686 or 1-916-356-3104.

Intel, the Intel logo, Intel SpeedStep, Intel Core, Core Inside, Intel vPro, Intel vPro Inside, Pentium, Pentium Inside, Celeron, Celeron Inside, Intel Atom, and Intel Atom Inside are trademarks of Intel Corporation in the U.S. and other countries.

\*Other names and brands may be claimed as the property of others.





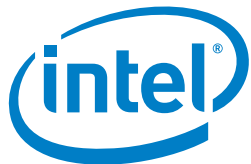







Copyright © 2008 Intel Corporation. All rights reserved. 1008/RR/MS Part Number: 308990-012US **October 2008**









# Recommend the Best Mobile Technology for Your Consumer Customer

## Mobile Consumer Matrix

USAGE	RECOMMENDED INTEL® PROCESSORS <sup>1</sup>	SELL-TO TIPPING POINT	NO. OF CORES	ENHANCED WIRELESS	BATTERY LIFE
 <b>Extreme Gaming</b>	 QX9000/X9000 series	Unrivaled mobile gaming and/or media performance	4/2	N/A	
 <b>Gaming and HD</b>	 Includes Intel® Core™2 Duo T9000 series	Enjoy visually intense gaming and high-definition media	2		
 <b>Everyday Performance</b>	 P9000/P8000 series	Create and store photos, videos, and music at home or on the go	2	N/A	
 <b>Just the Basics</b>	 500 series	Basic mobile computing at our lowest price point	1	N/A	

# Recommend the Best Mobile Technology for Your Business Customer

## Mobile Business Matrix

USAGE	RECOMMENDED INTEL® PROCESSOR <sup>1</sup> TECHNOLOGY	POSITIONING	BENEFITS AND USAGES	NO. OF CORES	ADDITIONAL FEATURES	PROOF POINTS
<b>Professional</b>	 <p>Includes Intel® Core™2 Duo Q9000/T9000/P9000/P8000 series</p>	Intel's best notebook technology for business, delivering industry-leading performance <sup>1</sup> and energy efficiency with hardware-assisted technologies that can help businesses enhance security and reduce overall support costs.	<ul style="list-style-type: none"> <li>Anywhere access to business systems</li> <li>Increased protection from viruses, spam, spyware, and data loss</li> <li>Minimal disruptions due to PC issues</li> <li>Advanced diagnostics and repair</li> <li>High-impact business productivity</li> </ul>	<b>4/2</b>	<ul style="list-style-type: none"> <li>Intel® vPro™ Technology</li> <li>Enhanced Wireless</li> <li>Increased Battery Life</li> <li>Outstanding Graphics</li> </ul>	<ul style="list-style-type: none"> <li>Advanced security and system manageability features to significantly reduce maintenance downtime and reduce the need for desk-side visits by up to 75%<sup>2,3</sup></li> <li>Includes wireless and battery benefits of Intel® Centrino™2 processor technology and performance benefits of the Intel® Core™2 Duo processor</li> </ul>
<b>Advanced</b>	 <p>Includes Intel® Core™2 Duo Q9000/T9000/P9000/P8000 series</p>	Smart, powerful mobile technology that offers top-tier performance, longer-lasting battery life, and the latest integrated wireless technology.	<ul style="list-style-type: none"> <li>Anywhere access to the Internet</li> <li>Maximum responsiveness while multitasking</li> <li>Optimal battery life</li> <li>Cross-functional collaboration</li> <li>Multimedia content development</li> </ul>	<b>4/2</b>	<ul style="list-style-type: none"> <li>Enhanced Wireless</li> <li>Increased Battery Life</li> <li>Outstanding Graphics</li> </ul>	<ul style="list-style-type: none"> <li>Integrated energy-saving components optimized to prolong battery life</li> <li>Operate wirelessly with greater link reliability and predictability, plus 5x better wireless performance than current 802.11g Wi-Fi<sup>4</sup></li> <li>Up to 30% faster when multitasking business applications<sup>5</sup></li> <li>Includes performance benefits of the Intel® Core™2 Duo processor</li> </ul>
<b>Basic</b>	 <p>P9000/P8000 series</p>	Provides leading, energy-efficient, multi-core performance.	<ul style="list-style-type: none"> <li>Performance for increased productivity while multitasking</li> <li>Advanced content development and editing</li> <li>Essential communication</li> </ul>	<b>2</b>		<ul style="list-style-type: none"> <li>Up to 35% faster on office productivity benchmarks<sup>6</sup></li> <li>Up to 48% faster on advanced Excel* (spreadsheet) calculations</li> </ul>
<b>Entry</b>	 <p>500 series</p>	A low-cost solution for basic computing from a trusted brand.	<ul style="list-style-type: none"> <li>Great for a first-time PC experience</li> <li>Perfect for handling individual activities, such as e-mail, Internet, and managing budgets</li> </ul>	<b>1</b>		<ul style="list-style-type: none"> <li>A balanced level of proven technology and excellent value</li> <li>Optimized for basic computing—Web surfing, e-mail, and word processing</li> </ul>

<sup>1</sup> Intel processor numbers are not a measure of performance. Processor numbers differentiate features within each processor family, not across different processor families. See [www.intel.com/products/processor\\_number/](http://www.intel.com/products/processor_number/) for details.

<sup>2</sup> (NOTEBOOK OR X\_CLIENT) Intel® Active Management Technology (Intel® AMT) requires the computer system to have an Intel AMT-enabled chipset, network hardware and software, as well as connection with a power source and a corporate network connection. Setup requires configuration by the purchaser and may require scripting with the management console or further integration into existing security frameworks to enable certain functionality. It may also require modifications of implementation of new business processes. With regard to notebooks, Intel AMT may not be available or certain capabilities may be limited over a host OS-based VPN or when connecting wirelessly, on battery power, sleeping, hibernating, or powered off. For more information, see [www.intel.com/technology/manage/iamt/](http://www.intel.com/technology/manage/iamt/).

<sup>3</sup> Results shown are from the 2007 EDS Case Studies with Intel® Centrino® Pro processor technology, 3rd party audit commissioned by Intel, of various enterprise IT environments. The studies compare test environments of Intel Centrino Pro processor technology equipped PCs vs non-Intel® vPro™ processor technology environments. Tested PCs were in multiple OS and power states to mirror a typical working environment. Actual results may vary. The study is available at [www.intel.com/vpro](http://www.intel.com/vpro) and [www.eds.com](http://www.eds.com).

<sup>4</sup> Up to 5x better performance with optional Intel® Next-Gen Wireless N technology enabled by 2x3 Draft N implementations with 2 spatial streams. Actual results may vary based on your specific hardware, connection rate, site conditions, and software configurations. See [www.intel.com/performance/mobile/index.htm](http://www.intel.com/performance/mobile/index.htm) for more information. Also requires a Connect with Intel® Centrino® processor technology-certified wireless n access point. Wireless n access points without the Connect with Intel Centrino processor technology identifier may require additional firmware for increased performance results. Check with your PC and access point manufacturer for details.

<sup>5</sup> Measured using SYSmark® 2007 Preview, BAPCo's latest version of the mainstream office productivity and Internet content creation benchmark tool used to characterize the performance of the business client, comparing latest generation Intel® Centrino® 2 processor technology-based notebooks with comparable frequency first-generation dual-core Intel Centrino processor technology-based notebooks. SYSmark 2007 Preview features user-driven workloads and usage models developed by application experts. Actual performance may vary. See [www.intel.com/go/consumerbenchmarks](http://www.intel.com/go/consumerbenchmarks) for important additional information.

<sup>6</sup> Comparing latest generation Intel® Centrino® 2 processor technology-based notebooks with comparable frequency to first-generation dual-core Intel Centrino processor technology-based notebooks. Actual performance may vary. See [www.intel.com/go/consumerbenchmarks](http://www.intel.com/go/consumerbenchmarks) for important additional information.

Performance tests and ratings are measured using specific computer systems and/or components, and reflect the approximate performance of Intel products as measured by those tests. Any difference in system hardware or software design or configuration may affect actual performance. Buyers should consult other sources of information to evaluate the performance of systems or components they are considering purchasing. For more information on performance tests and on the performance of Intel products, visit [www.intel.com/performance/](http://www.intel.com/performance/) or call (U.S.) 1-800-628-8686 or 1-916-356-3104.

Intel, the Intel logo, Intel Core, Core Inside, Celeron, Celeron Inside, Centrino, Centrino Inside, Intel vPro, and Intel vPro Inside are trademarks of Intel Corporation in the U.S. and other countries.

\*Other names and brands may be claimed as the property of others.

Copyright © 2008 Intel Corporation. All rights reserved. 1008/RR/MS Part Number: 317979-005US **October 2008**



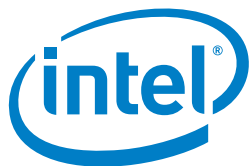

# Better Together: Recommend the Best Intel® Xeon® Processor and Intel® Chipset

## Server Business Matrix



SEGMENT	POSITIONING	RECOMMENDED CPU SERIES <sup>1</sup>	MAX. SOCKETS PER SYSTEM	NO. OF CORES	MAX. FREQ. <sup>2</sup>	POWER	MAX. FRONT SIDE BUS	CACHE	RECOMMENDED INTEL® CHIPSET
<b>Expandable</b> Leading Performance, Reliability, and Scalability <b>TARGET USAGE:</b> Optimized for large enterprises, data centers, and server consolidation <b>RECOMMENDED CONFIGURATION:</b> 4+ CPUs	Best	Intel® Xeon® 7400 Series	4	4	2.67 GHz	50-130 W	1066 MHz	16 MB L3	Intel® 7400 Chipset
<b>Efficient Performance</b> Energy Efficient, Cost Effective <b>TARGET USAGE:</b> Optimized for General Purpose Servers (e-mail, Web, file, business applications) and IT infrastructure virtualization <b>RECOMMENDED CONFIGURATION:</b> 2 CPUs	Best	Intel® Xeon® 5400 Series	2	4	3.33 GHz	80-120 W	1333 MHz	12 MB L2	Intel® 5000P Chipset
	Good	Intel® Xeon® 3300 Series	1	4	3 GHz	95 W	1333 MHz	Up to 12 MB L2	Intel® 3200 Chipset
<b>Entry</b> Cost Optimized <b>TARGET USAGE:</b> Small businesses < 100 employees, Basic needs (e-mail, network, file/print) <b>RECOMMENDED CONFIGURATION:</b> 1-2 CPUs	Best	Intel® Xeon® 5400 Series	2	4	3.33 GHz	80-120 W	1333 MHz	Up to 12 MB L2	Intel® 5000V or Intel® 5100 Chipset
		Intel® Xeon® 5200 Series	2	2	1.86 GHz	65 W	1066 MHz	Up to 6 MB L2	
	Better	Intel® Xeon® 3300 Series	1	4	3 GHz	95 W	1333 MHz	Up to 12 MB L2	Intel® 3200 Chipset
	Good	Intel® Xeon® 3100 Series	1	2	3.16 GHz	65 W	1333 MHz	6 MB L2	Intel® 3200 Chipset

# Better Together: Recommend the Best Intel® Xeon® Processor and Intel® Chipset

## Server Platforms Matrix

SEGMENT	POSITIONING	RECOMMENDED CPU SERIES <sup>1</sup>	MAX. CPUs PER SYSTEM	NO. OF CORES	MAX. FREQ. <sup>2</sup>	POWER	MAX. FRONT SIDE BUS	CACHE	RECOMMENDED INTEL® CHIPSET
<b>HPC</b> Optimized for High-Performance Analytics  <b>TARGET USAGES:</b> Bandwidth-intensive applications, High-Performance Clusters, and complex computation	Best	Intel® Xeon® 5400 Series	2	4	3.20 GHz	80-120 W	1600 MHz	12 MB L2	Intel® 5400 Chipset
	Better	Intel® Xeon® 5400 Series Low Voltage SKUs (L54xx)	2	4	2.66 GHz	50 W	1333 MHz	12 MB L2	Intel® 5100 Chipset
	Good	Intel® Xeon® 5200 Series Low Voltage SKUs (L52xx)	2	2	3.40 GHz	40-80 W	1600 MHz	6 MB L2	Intel® 5100 Chipset
	Low-cost HPC	Intel® Xeon® 3300 Series	2	4	2 GHz	95 W	1333 MHz	Up to 12 MB L2	Intel® 3200 or Intel® X38 Chipset
<b>Workstation</b> Optimized for Complex Analysis/Visualization  <b>TARGET USAGES:</b> Graphics rendering, multimedia content development, engineering applications (CAD/CAM), software development	Best	Intel® Xeon® 5400 Series	2	4	3.40 GHz	80-150 W	1600 MHz	12 MB L2	Intel® 5400 Chipset
	Good	Intel® Xeon® 5400 Series	2	4	3.33 GHz	50-120 W	1333 MHz	12 MB L2	Intel® 5400 Chipset

<sup>1</sup> Intel processor numbers are not a measure of performance. Processor numbers differentiate features within each processor family, not across different processor families. See [www.intel.com/products/processor\\_number/](http://www.intel.com/products/processor_number/) for details.

<sup>2</sup> Processor frequency as shown represents maximum frequency specification for the respective processor number family.

Intel, the Intel logo, Xeon, and Xeon Inside are trademarks of Intel Corporation in the U.S. and other countries.

\*Other names and brands may be claimed as the property of others.

Copyright © 2008 Intel Corporation. All rights reserved. 1008/RR/MS Part Number: 316057-008US **October 2008**

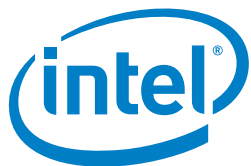

# INTEL® DESKTOP PROCESSORS

INTEL CONFIDENTIAL



PROCESSOR NAME	PRODUCT CODE	CLOCK SPEED	MEMORY SPEED	CACHE	PACKAGE	UPC CODE
Intel® Core™ i7-965 Processor Extreme Edition	<b>BX80601965</b>	3.20 GHz	1333 MHz <sup>1</sup>	8 MB L3 shared	LGA1366	7 35858 20471 2
Intel® Core™2 Extreme Quad-Core Processor QX9775	<b>BX805740X9557</b>	3.20 GHz	<b>1600 MHz</b>	12 MB L2 shared	LGA771	7 35858 19945 2
Intel Core 2 Extreme Quad-Core Processor QX9770	<b>BX805690X9770</b>	3.20 GHz	<b>1600 MHz</b>	12 MB L2 shared	LGA775	7 35858 19756 4
Intel Core 2 Extreme Quad-Core Processor QX9650	<b>BX805690X9650</b>	3 GHz	1333 MHz	12 MB L2 shared	LGA775	7 35858 19802 8
PROCESSOR NAME	PRODUCT CODE	CLOCK SPEED	MEMORY SPEED	CACHE	PACKAGE	UPC CODE
Intel® Core™ i7-940 Processor	<b>BX80601940</b>	2.93 GHz	1066 MHz	8 MB L3 shared	LGA1366	7 35858 20472 9
Intel Core i7-920 Processor	<b>BX80601920</b>	2.66 GHz	1066 MHz	8 MB L3 shared	LGA1366	7 35858 20473 6
Intel® Core™2 Quad Processor Q9650	<b>BX805690Q9650</b>	3 GHz	<b>1333 MHz</b>	12 MB L2 shared	LGA775	7 35858 20342 5
Intel Core 2 Quad Processor Q9550	<b>BX805690Q9550</b>	2.80 GHz	<b>1333 MHz</b>	12 MB L2 shared	LGA775	7 35858 19738 0
Intel Core 2 Quad Processor Q9450	<b>BX805690Q9450</b>	2.66 GHz	<b>1333 MHz</b>	12 MB L2 shared	LGA775	7 35858 19849 3
Intel Core 2 Quad Processor Q9400	<b>BX805800Q9400</b>	2.66 GHz	<b>1333 MHz</b>	6 MB L2 shared	LGA775	7 35858 20307 4
Intel Core 2 Quad Processor Q9300	<b>BX805800Q9300</b>	2.50 GHz	<b>1333 MHz</b>	6 MB L2 shared	LGA775	7 35858 19975 9
Intel Core 2 Quad Processor Q8200	<b>BX805800Q8200</b>	2.33 GHz	<b>1333 MHz</b>	4 MB L2 shared	LGA775	7 35858 20385 2
Intel Core 2 Quad Processor Q6700	<b>BX805620Q6700</b>	2.66 GHz	1066 MHz	8 MB L2 shared	LGA775	7 35858 19541 6
Intel Core 2 Quad Processor Q6600	<b>BX805620Q6600</b>	2.40 GHz	1066 MHz	8 MB L2 shared	LGA775	7 35858 19156 2

For more information, visit the Intel Web site at: [www.intel.com/go/desktopprocessors](http://www.intel.com/go/desktopprocessors)

PROCESSOR NAME	PRODUCT CODE	CLOCK SPEED	MEMORY SPEED	CACHE	PACKAGE	UPC CODE
Intel® Core™2 Duo Processor E8600	BX80570E8600	3.33 GHz	<b>1333 MHz</b>	6 MB L2 shared	LGA775	7 35858 20306 7
Intel Core 2 Duo Processor E8500	BX80570E8500	3.16 GHz	<b>1333 MHz</b>	6 MB L2 shared	LGA775	7 35858 19963 6
Intel Core 2 Duo Processor E8400	BX80570E8400	3 GHz	<b>1333 MHz</b>	6 MB L2 shared	LGA775	7 35858 19964 3
Intel Core 2 Duo Processor E8200	BX80570E8200	2.66 GHz	<b>1333 MHz</b>	6 MB L2 shared	LGA775	7 35858 19965 0
Intel Core 2 Duo Processor E7400	BX80571E7400	2.80 GHz	1066 MHz	3 MB L2 shared	LGA775	7 35858 20503 0
Intel Core 2 Duo Processor E7300	BX80571E7300	2.66 GHz	1066 MHz	3 MB L2 shared	LGA775	7 35858 20353 1
Intel Core 2 Duo Processor E7200	BX80571E7200	2.53 GHz	1066 MHz	3 MB L2 shared	LGA775	7 35858 20192 6
Intel Core 2 Duo Processor E5200	BX80571E5200	2.50 GHz	800 MHz	2 MB L2 shared	LGA775	7 35858 20388 3
Intel Core 2 Duo Processor E4700	BX80557E4700	2.60 GHz	800 MHz	2 MB L2 shared	LGA775	7 35858 20018 9
Intel Core 2 Duo Processor E4600	BX80557E4600	2.40 GHz	800 MHz	2 MB L2 shared	LGA775	7 35858 19769 4
PROCESSOR NAME	PRODUCT CODE	CLOCK SPEED	MEMORY SPEED	CACHE	PACKAGE	UPC CODE
Intel® Pentium® Dual-Core Processor E2220	BX80557E2220	2.40 GHz	<b>800 MHz</b>	1 MB L2 shared	LGA775	7 35858 20138 4
Intel Pentium Dual-Core Processor E2200	BX80557E2200	2.20 GHz	<b>800 MHz</b>	1 MB L2 shared	LGA775	7 35858 19978 0
Intel Pentium Dual-Core Processor E2180	BX80557E2180	2 GHz	<b>800 MHz</b>	1 MB L2 shared	LGA775	7 35858 19636 9
Intel Pentium Dual-Core Processor E2160	BX80557E2160	1.80 GHz	<b>800 MHz</b>	1 MB L2 shared	LGA775	7 35858 19374 0
PROCESSOR NAME	PRODUCT CODE	CLOCK SPEED	MEMORY SPEED	CACHE	PACKAGE	UPC CODE
Intel® Celeron® Dual-Core Processor E1400	BX80557E1400	2 GHz	<b>800 MHz</b>	512 KB L2	LGA775	7 35858 20189 6
Intel Celeron Dual-Core Processor E1200	BX80557E1200	1.60 GHz	<b>800 MHz</b>	512 KB L2	LGA775	7 35858 19953 7
PROCESSOR NAME	PRODUCT CODE	CLOCK SPEED	MEMORY SPEED	CACHE	PACKAGE	UPC CODE
Intel® Celeron® Processor 440	BX80557440	2 GHz	<b>800 MHz</b>	512 KB L2	LGA775	7 35858 19365 8
Intel Celeron Processor 430	BX80557430	1.80 GHz	<b>800 MHz</b>	512 KB L2	LGA775	7 35858 19366 5

<sup>1</sup> 1333 MHz expected through a microcode update post launch

Please refer to the product quick reference matrix located on Intel Reseller Center: [www.intel.com/reseller](http://www.intel.com/reseller)

Intel processor numbers are not a measure of performance. Processor numbers differentiate features within each processor family, not across different processor families. See [www.intel.com/products/processor\\_number](http://www.intel.com/products/processor_number) for more details.

All products and dates specified are preliminary based on current expectations and are subject to change without notice. Availability in different channels may vary.

Intel, the Intel logo, Intel Core, Core Inside, Pentium, Pentium Inside, Celeron, and Celeron Inside are trademarks of Intel Corporation in the U.S. and other countries.

\*Other names and brands may be claimed as the property of others.

Copyright © 2008 Intel Corporation. All rights reserved. 1008/RR/MS Part Number: 252623-025US **October 2008**

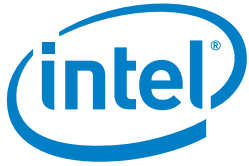

**INTEL® DESKTOP BOARDS**  
**Intel® Desktop Boards**  
 Designed for performance.



INTEL® DESKTOP BOARDS / INTEL® DESKTOP ADAPTERS

	Desktop Board	Form Factor	Processor Technology	Memory	Integrated Graphics	PCIe* x16	PCIe x1	PCI	PATA (devices)	SATA	eSATA	RAID	Audio 2.0	USB	1394	1600 FSB	1333 FSB	1066 FSB	1333 FSB	1066 FSB	1333 FSB	1066 FSB	800 FSB	800 FSB	800/533 FSB	533 FSB	
Extreme	DX58SO	ATX		DDR3 1333		2	1	1		6	2	▪	10-ch	8+4	1+1	▪											
	D5400XS	EATX		FBDIMM 800		4		2		6	2	▪	10-ch	6+4	1+1		▪	▪									
	DX48BT2	ATX		DDR3 1600		3		2	1(2)	6	2	▪	10-ch	8+4	1+1		▪	▪	▪								
	DX38BT	ATX		DDR3 1333		3		2	1(2)	6	2	▪	10-ch	8+4	1+1			▪	▪	▪	▪						
	DP45SG	ATX		DDR3 1333		2	2	3		5	1	▪	8-ch	6+6	1+1			▪	▪	▪	▪						
Media	DG45ID	µATX	Viiv	DDR2 800	HDMI+DVI	1	2	1		5	1	▪	8-ch	6+6	1+1												
	DG45FC	mini-ITX	Viiv	DDR2 800	HDMI+DVI		1			4	1	▪	8-ch	6+4													
	DP35DP	ATX	Viiv	DDR2 800		1	3	3	1(2)	6	1	▪	8-ch	6+6	1+1												
	DG33TL	µATX	Viiiv	DDR2 800	DVI+VGA	1	2	1	1(2)	6	1	▪	8-ch	6+6	1+1												
	DQ45CB	µATX	vPro	DDR2 800	DVI+DVI	1	2	1		5	1	▪	6-ch	6+6	1+1												
Executive	DQ45EK	mini-ITX	vPro	DDR2 800	DVI+DVI		1			4	1	▪	6-ch	6+4													
	DQ35J0	µATX	vPro	DDR2 800	DVI+VGA	1	2	1	1(2)	6	1	▪	4-ch	6+6	1+1												
	DQ35MP	µATX	vPro	DDR2 800	VGA	1	2	1	1(2)	6	1	▪	4-ch	6+6													
	DQ965GF	µATX	vPro	DDR2 800	VGA	1	1	2	1(2)	6		▪	6-ch	6+4	1+1												
	DG43NB	ATX	Viiv	DDR2 800	DVI+VGA	1	3	3	1(2)	6			6-ch	6+6	1+1												
Classic	DP43TF	ATX	Viiv	DDR2 800		1	3	3	1(2)	6			6-ch	6+6	1+1												
	DG41TY	µATX		DDR2 800	DVI+VGA	1	1	2	1(2)	4			6-ch	4+4													
	DG35EC	µATX		DDR2 800	DVI+VGA	1	2	1	1(2)	4			6-ch	6+4	1+1												
	DG33FB	ATX	Viiv	DDR2 800	VGA	1	3	3	1(2)	4			6-ch	6+6	1+1												
	DG33BU	µATX	Viiv	DDR2 800	VGA	1	1	2	1(2)	4			6-ch	6+6	1+1												
DG31PR	µATX		DDR2 800	VGA	1	1	2	1(2)	4			6-ch	4+4														
Essential	D945GCLF2	mini-ITX		DDR2 667	VGA+S-video			1	1(2)	2			6-ch	4+4													
	D945GCLF	mini-ITX		DDR2 667	VGA			1	1(2)	2			4-ch	4+2													
	D945GCPE	µATX		DDR2 667	VGA			2	1(2)	2			4-ch	4+4													
	DG31GL	µATX		DDR2 800	VGA			2	1(2)	2			4-ch	4+4													
	D945GCNL	µATX		DDR2 667	VGA	1	1	2	1(2)	4			6-ch	4+4													

Intel® Clear Video technology uses hardware video acceleration, de-interlacing technology, ProcAmp color controls, and other post-processor capabilities to deliver smooth, sharp, vibrant video images.

For more information, visit the Intel Web site at: <http://www.intel.com/products/motherboard/>



Series	Extreme Series		Extreme Series		Extreme Series	
<b>Product Family</b>	Intel® Desktop Board DX58SO		Intel® Desktop Board D5400XS		Intel® Desktop Board DX48BT2	
<b>Form Factor</b>	ATX		EATX (13" x 12")		ATX	
<b>Product Code/UPC</b>	BOXDX58SO / 00735858203036		BOXD5400XS / 00735858200615		BOXDX48BT2 / 00735858199766	
<b>10-pack Product Code/UPC</b>	BLKDX58SO / 00735858203043		N/A		BLKDX48BT2 / 00735858199773	
<b>Processor Support</b>	Intel® Core™ i7 processor Extreme Edition in the LGA1366 package		Single or Dual Intel® Core™2 Extreme Quad-Core and Single or Dual Intel® Xeon® processors in the LGA771 package		Intel® Core™2 Extreme, Intel® Core™2 Quad, Intel® Core™2 Duo, Intel® Pentium® Dual-Core, and Intel® Celeron® Dual-Core processors in the LGA775 package	
<b>Supported FSB</b>	N/A		1600 MHz / 1333 MHz / 1066 MHz		1600 MHz / 1333 MHz / 1066 MHz	
<b>Chipset</b>	Intel® X58 Express Chipset		Intel® 5400 Express Chipset		Intel® X48 Express Chipset with ICH9R	
<b>Supports HT Technology<sup>1</sup></b>	Yes		No		No	
<b>Graphics</b>	None		None		None	
<b>Graphics Connector</b>	2 PCI Express* 2.0 x16 (electrical x16, 2nd Gen PCIe)		4 PCI Express* 1.0 x16 (electrical x16)		2 PCI Express* 2.0 x16 (electrical x16, 2nd Gen PCIe) 1 PCI Express x16 (electrical x4)	
<b>Memory Support</b>	DDR3 1066 / 1333 / 1600 SDRAM 4 slots (8 GB <sup>2</sup> max)		FBDIMM 800 MHz, Quad-channel (16 GB <sup>2</sup> max)		DDR3 1600 / 1333 SDRAM 4 slots, Dual-channel (8 GB <sup>2</sup> max)	
<b>Expansion Slots</b>	1 PCI		2 PCI		1 PCI Express x16 (electrical x4), 2 PCI	
<b>Audio</b>	Intel® High Definition Audio: 10-channel audio with jack sensing (back ports: 5 analog, 1 optical, 1 coax). Board supports Dolby® Home Theater		Intel® High Definition Audio: 10-channel audio with jack sensing (back ports: 5 analog, 1 optical, 1 coax). Board supports Dolby® Home Theater		Intel® High Definition Audio: 10-channel audio with jack sensing (back ports: 5 analog, 1 optical, 1 coax). Board supports Dolby® Home Theater	
<b>USB Ports</b>	12 Hi-Speed USB 2.0, 8 back ports / 4 ports via 2 internal headers		10 Hi-Speed USB 2.0, 6 back ports / 4 ports via 2 internal headers		12 Hi-Speed USB 2.0, 8 back ports / 4 ports via 2 internal headers	
<b>1394</b>	Up to 2 IEEE 1394a ports (1 back port, 1 via internal header)		Up to 2 IEEE 1394a ports (1 back port, 1 via internal header)		Up to 2 IEEE 1394a ports (1 back port, 1 via internal header)	
<b>Storage</b>	6-port SATA (3.0 Gb/s) and 2-port eSATA		6-port SATA (3.0 Gb/s) and 2-port eSATA		6-port SATA (3.0 Gb/s) and 2-port eSATA	
<b>RAID</b>	Intel® Matrix Storage Technology (RAID 0, 1, 5, 10, with Intel® Rapid Recover Technology)		Intel® Matrix Storage Technology (RAID 0, 1, 5, 10, with Intel® Rapid Recover Technology)		Intel® Matrix Storage Technology (RAID 0, 1, 5, 10, with Intel® Rapid Recover Technology)	
<b>Onboard LAN</b>	Intel® PRO 10/100/1000 Network Connection		Intel® PRO 10/100/1000 Network Connection		Intel® PRO 10/100/1000 Network Connection	
<b>TPM</b>	No		No		No	
<b>Lead Free</b>	Yes		Yes		Yes	
<b>Software</b>	Intel® Desktop Control Center Intel® Integrator Assistant Acronis® True Image 11 Home CyberLink® Live Premium Diskeeper® Home Edition DivX® Pro for Windows® Dolby® Control Center Norton 360® PLAYXPRT® In-Game Platform Kaspersky® Anti-Virus <sup>3</sup> Kingsoft® Antivirus <sup>4</sup> Kingsoft® Powerword <sup>4*</sup>		Diskeeper® Home Edition DivX® for Windows® Dolby® Control Center Norton AntiVirus® TypePad® Kaspersky® Anti-Virus <sup>3</sup> Kingsoft® Antivirus <sup>4</sup> Kingsoft® Powerword <sup>4*</sup>		Intel® Desktop Control Center Intel® Integrator Assistant Intel® Integrator Toolkit Diskeeper® Home Edition DivX® for Windows® Dolby® Control Center Norton AntiVirus® TypePad® Kaspersky® Anti-Virus <sup>3</sup> Kingsoft® Antivirus <sup>4</sup> Kingsoft® Powerword <sup>4*</sup>	
<b>Intel® Advanced BIOS</b>	Intel® Express BIOS Update Intel® Platform Innovation Framework for the Extensible Firmware Interface (EFI) Intel® Precision Cooling Technology	Intel® Rapid BIOS Boot Digital Signature Technology Fault Tolerant Flashing Multiple Language Support	Intel® Express BIOS Update Intel® Platform Innovation Framework for the Extensible Firmware Interface (EFI) Intel® Precision Cooling Technology	Intel® Rapid BIOS Boot Digital Signature Technology Fault Tolerant Flashing Multiple Language Support	Intel® Express BIOS Update Intel® Platform Innovation Framework for the Extensible Firmware Interface (EFI) Intel® Precision Cooling Technology	Intel® Rapid BIOS Boot Digital Signature Technology Fault Tolerant Flashing Multiple Language Support
<b>Windows Vista® and WHQL Support</b>	Windows Vista® Premium		Windows Vista® Premium		Windows Vista® Premium	
<b>Warranty</b>	3 year limited warranty		3 year limited warranty		3 year limited warranty	



Series	Extreme Series	Extreme Series	Media Series	
<b>Product Family</b>	Intel® Desktop Board DX38BT	Intel® Desktop Board DP45SG	Intel® Desktop Board DG45ID	
<b>Form Factor</b>	ATX	ATX	MicroATX	
<b>Product Code/UPC</b>	<b>BOXDX38BT / 00735858194525</b>	<b>BOXDP45SG / 00735858200356</b>	<b>BOXDG45ID / 00735858200387</b>	
<b>10-pack Product Code/UPC</b>	BLKDX38BT / 00735858194532	BLKDP45SG / 00735858200363	BLKDG45ID / 00735858200394	
<b>Processor Support</b>	Intel® Core™2 Extreme, Intel® Core™2 Quad, Intel® Core™2 Duo, Intel® Pentium® Dual-Core, and Intel® Celeron® Dual-Core processors in the LGA775 package	Intel® Core™2 Extreme, Intel® Core™2 Quad, Intel® Core™2 Duo, Intel® Pentium® Dual-Core, Intel® Celeron® Dual-Core, and Intel® Celeron® processors in the LGA775 package	Intel® Core™2 Quad, Intel® Core™2 Duo, Intel® Pentium® Dual-Core, Intel® Celeron® Dual-Core, and Intel® Celeron® processors in the LGA775 package	
<b>Supported FSB</b>	1333 MHz / 1066 MHz	1333 MHz / 1066 MHz / 800 MHz	1333 MHz / 1066 MHz / 800 MHz	
<b>Chipset</b>	Intel® X38 Express Chipset with ICH9R	Intel® P45 Express Chipset with ICH10R	Intel® G45 Express Chipset with ICH10R	
<b>Supports HT Technology<sup>1</sup></b>	No	No	No	
<b>Graphics</b>	None	None	Integrated Intel® Graphics Media Accelerator X4500HD with Intel® Clear Video Technology	
<b>Graphics Connector</b>	2 PCI Express* 2.0 x16 (electrical x16, 2nd Gen PCIe) 1 PCI Express x16 (electrical x4)	2 PCI Express* 2.0 x16 (electrical x16, 2nd Gen PCIe)	1 PCI Express* x16	
<b>Memory Support</b>	DDR3 1333 SDRAM 4 slots, Dual-channel (8 GB <sup>2</sup> max)	DDR3 1333 / 1066 / 800 SDRAM 4 slots, Dual-channel (8 GB <sup>2</sup> max)	DDR2 800 / 667 SDRAM 4 slots, Dual-channel (8 GB <sup>2</sup> max)	
<b>Expansion Slots</b>	1 PCI Express x16 (electrical x4), 2 PCI	2 PCI Express x1, 3 PCI	2 PCI Express x1, 1 PCI	
<b>Audio</b>	Intel® High Definition Audio: 10-channel audio with jack sensing (back ports: 5 analog, 1 optical, 1 coax). Board supports Dolby® Home Theater	Intel® High Definition Audio: 8-channel audio with jack sensing (back ports: 5 analog, 1 optical). Board supports Dolby® Home Theater	Intel® High Definition Audio: 8-channel audio with jack sensing (back ports: 5 analog, 1 optical). Board supports Dolby® Home Theater	
<b>USB Ports</b>	12 Hi-Speed USB 2.0, 8 back ports / 4 ports via 2 internal headers	12 Hi-Speed USB 2.0, 6 back ports / 6 ports via 2 internal headers	12 Hi-Speed USB 2.0, 6 back ports / 6 ports via 2 internal headers	
<b>1394</b>	Up to 2 IEEE 1394a ports (1 back port, 1 via internal header)	Up to 2 IEEE 1394a ports (1 back port, 1 via internal header)	Up to 2 IEEE 1394a ports (1 back port, 1 via internal header)	
<b>Storage</b>	6-port SATA (3.0 Gb/s) and 2-port eSATA	5-port SATA and 1-port eSATA (3.0 Gb/s)	5-port SATA and 1-port eSATA (3.0 Gb/s)	
<b>RAID</b>	Intel® Matrix Storage Technology (RAID 0, 1, 5, 10, with Intel® Rapid Recover Technology)	Intel® Matrix Storage Technology (RAID 0, 1, 5, 10, with Intel® Rapid Recover Technology)	Intel® Matrix Storage Technology (RAID 0, 1, 5, 10, with Intel® Rapid Recover Technology)	
<b>Onboard LAN</b>	Intel® PRO 10/100/1000 Network Connection	Intel® PRO 10/100/1000 Network Connection	Intel® PRO 10/100/1000 Network Connection	
<b>TPM</b>	No	No	No	
<b>Lead Free</b>	Yes	Yes	Yes	
<b>Software</b>	Ghost Recon Advanced Warfighter* 2 Intel® Desktop Control Center Intel® Integrator Assistant Intel® Integrator Toolkit Diskeeper* Home Edition DivX* for Windows* Dolby® Control Center Norton AntiVirus*	Skype* TypePad* Kaspersky* Anti-Virus <sup>3</sup> Kingsoft* Antivirus <sup>4</sup> Kingsoft* Powerword* <sup>4</sup>	Intel® Desktop Control Center Intel® Integrator Assistant Acronis* True Image 11 Home CyberLink* Live Premium Diskeeper* Home Edition DivX* Pro for Windows* Dolby® Control Center Laplink* PCmover* Express Norton 360*	Skype* TypePad* Kaspersky* Anti-Virus <sup>3</sup> Kingsoft* Antivirus <sup>4</sup> Kingsoft* Powerword* <sup>4</sup>
<b>Intel® Advanced BIOS</b>	Intel® Express BIOS Update Intel® Platform Innovation Framework for the Extensible Firmware Interface (EFI) Intel® Precision Cooling Technology	Intel® Rapid BIOS Boot Intel® Rapid BIOS Boot Digital Signature Technology Fault Tolerant Flashing Multiple Language Support	Intel® Express BIOS Update Intel® Platform Innovation Framework for the Extensible Firmware Interface (EFI) Intel® Quiet System Technology Intel® Rapid BIOS Boot	Digital Signature Technology Fault Tolerant Flashing Multiple Language Support
<b>Windows Vista* and WHQL Support</b>	Windows Vista* Premium	Windows Vista* Premium	Windows Vista* Premium	
<b>Warranty</b>	3 year limited warranty	3 year limited warranty	3 year limited warranty	



Series	Media Series	Media Series	Media Series
<b>Product Family</b>	Intel® Desktop Board DG45FC	Intel® Desktop Board DP35DP	Intel® Desktop Board DG33TL
<b>Form Factor</b>	Mini-ITX, MicroATX-compatible	ATX	MicroATX
<b>Product Code/UPC</b>	<b>BOXDG45FC / 00735858200417</b>	<b>BOXDP35DPM / 00735858192453</b>	<b>BOXDG33TLM / 00735858193634</b>
<b>10-pack Product Code/UPC</b>	BLKDG45FC / 00735858200424	BLKDP35DPM / 00735858192460	BLKDG33TLM / 00735858193627
<b>Processor Support</b>	Intel® Core™2 Duo, Intel® Pentium® Dual-Core, Intel® Celeron® Dual-Core, and Intel® Celeron® processors in the LGA775 package	Intel® Core™2 Quad, Intel® Core™2 Duo, Intel® Pentium® Dual-Core, Intel® Celeron® Dual-Core, and Intel® Celeron® processors in the LGA775 package	Intel® Core™2 Quad, Intel® Core™2 Duo, Intel® Pentium® Dual-Core, Intel® Celeron® Dual-Core, and Intel® Celeron® processors in the LGA775 package
<b>Supported FSB</b>	1333 MHz / 1066 MHz / 800 MHz	1333 MHz / 1066 MHz / 800 MHz	1333 MHz / 1066 MHz / 800 MHz
<b>Chipset</b>	Intel® G45 Express Chipset with ICH10R	Intel® P35 Express Chipset with ICH9R	Intel® G33 Express Chipset with ICH9R
<b>Supports HT Technology<sup>1</sup></b>	No	No	No
<b>Graphics</b>	Integrated Intel® Graphics Media Accelerator X4500HD with Intel® Clear Video Technology	None	Integrated Intel® Graphics Media Accelerator 3100 with Intel® Clear Video Technology
<b>Graphics Connector</b>	N/A	PCI Express* x16	PCI Express* x16
<b>Memory Support</b>	DDR2 800 / 667 SDRAM 2 slots, Dual-channel (4 GB <sup>2</sup> max)	DDR2 800 / 667 SDRAM 4 slots, Dual-channel (8 GB <sup>2</sup> max)	DDR2 800 / 667 SDRAM 4 slots, Dual-channel (8 GB <sup>2</sup> max)
<b>Expansion Slots</b>	1 PCI Express x1	3 PCI Express x1, 3 PCI	2 PCI Express x1, 1 PCI
<b>Audio</b>	Intel® High Definition Audio: 8-channel audio with jack sensing (back ports: 5 analog, 1 optical). Board supports Dolby® Home Theater	Intel® High Definition Audio: 8-channel audio with jack sensing (back ports: 5 analog, 1 optical). Board supports Dolby® Home Theater	Intel® High Definition Audio: 8-channel audio with jack sensing (back ports: 5 analog, 1 optical). Board supports Dolby® Home Theater
<b>USB Ports</b>	10 Hi-Speed USB 2.0, 6 back ports / 4 ports via 2 internal headers	12 Hi-Speed USB 2.0, 6 back ports / 6 ports via internal headers	12 Hi-Speed USB 2.0, 6 back ports / 6 ports via internal headers
<b>1394</b>	N/A	Up to 2 IEEE 1394a ports (1 back port, 1 via internal header)	Up to 2 IEEE 1394a ports (1 back port, 1 via internal header)
<b>Storage</b>	4-port SATA and 1-port eSATA (3.0 Gb/s)	6-port SATA and 1-port eSATA (3.0 Gb/s)	6-port SATA and 1-port eSATA (3.0 Gb/s)
<b>RAID</b>	Intel® Matrix Storage Technology (RAID 0, 1, 5, 10, with Intel® Rapid Recover Technology)	Intel® Matrix Storage Technology (RAID 0, 1, 5, 10, with Intel® Rapid Recover Technology)	Intel® Matrix Storage Technology (RAID 0, 1, 5, 10, with Intel® Rapid Recover Technology)
<b>Onboard LAN</b>	Intel® PRO 10/100/1000 Network Connection	Intel® PRO 10/100/1000 Network Connection	Intel® PRO 10/100/1000 Network Connection
<b>TPM</b>	No	No	No
<b>Lead Free</b>	Yes	Yes	Yes
<b>Software</b>	Intel® Integrator Assistant Intel® Integrator Toolkit Acronis® True Image 11 Home CyberLink® Live Premium Diskeeper® Home Edition DivX® Pro for Windows® Dolby® Control Center Laplink® PCmover® Express Norton Antivirus® Skype® TypePad®	Kaspersky® Anti-Virus <sup>3</sup> Kingsoft® Antivirus <sup>4</sup> Kingsoft® Powerword <sup>4</sup>	Intel® Integrator Assistant Intel® Integrator Toolkit Diskeeper® Home Edition DivX® for Windows® Dolby® Control Center Norton AntiVirus® Skype® TypePad® Kaspersky® Anti-Virus <sup>3</sup> Kingsoft® Antivirus <sup>4</sup> Kingsoft® Powerword <sup>4</sup>
<b>Intel® Advanced BIOS</b>	Intel® Express BIOS Update Intel® Platform Innovation Framework for the Extensible Firmware Interface (EFI) Intel® Quiet System Technology Intel® Rapid BIOS Boot	Digital Signature Technology Fault Tolerant Flashing Multiple Language Support	Intel® Express BIOS Update Intel® Platform Innovation Framework for the Extensible Firmware Interface (EFI) Intel® Quiet System Technology Intel® Rapid BIOS Boot
<b>Digital Signature Technology</b>			
<b>Windows Vista® and WHQL Support</b>	Windows Vista® Premium	Windows Vista® Premium	Windows Vista® Premium
<b>Warranty</b>	3 year limited warranty	3 year limited warranty	3 year limited warranty



Series	Executive Series – Supports Intel® vPro™ Technology		Executive Series – Supports Intel® vPro™ Technology		Executive Series – Supports Intel® vPro™ Technology	
Product Family	Intel® Desktop Board DQ45CB		Intel® Desktop Board DQ45EK		Intel® Desktop Board DQ35JO	
Form Factor	MicroATX		Mini-ITX, MicroATX-compatible		MicroATX	
Product Code/UPC	<b>BOXDQ45CB / 00735858200295</b>		<b>BOXDQ45EK / 00735858200325</b>		<b>BOXDQ35JOE / 00735858888804</b>	
10-pack Product Code/UPC	BLKDQ45CB / 00735858200301		BLKDQ45EK / 00735858200332		BLKDQ35JOE / 00735858888802	
Processor Support	<b>Intel® Core™2 Quad, Intel® Core™2 Duo, Intel® Pentium® Dual-Core, Intel® Celeron® Dual-Core, and Intel® Celeron® processors in the LGA775 package</b>		<b>Intel® Core™2 Duo, Intel® Pentium® Dual-Core, Intel® Celeron® Dual-Core, and Intel® Celeron® processors in the LGA775 package</b>		<b>Intel® Core™2 Quad, Intel® Core™2 Duo, Intel® Pentium® Dual-Core, Intel® Celeron® Dual-Core, and Intel® Celeron® processors in the LGA775 package</b>	
Supported FSB	1333 MHz / 1066 MHz / 800 MHz		1333 MHz / 1066 MHz / 800 MHz		1333 MHz / 1066 MHz / 800 MHz	
Chipset	Intel® Q45 Express Chipset with ICH10D Intel® Active Management Technology Specification 5.0		Intel® Q45 Express Chipset with ICH10D Intel® Active Management Technology Specification 5.0		Intel® Q35 Express Chipset with ICH9DD Intel® Active Management Technology Specification 3.0	
Supports HT Technology <sup>1</sup>	No		No		No	
Graphics	Intel® Graphics Media Accelerator 4500 with Dual-Independent Display capability (DVI-D + DVI-I outputs)		Intel® Graphics Media Accelerator 4500 with Dual-Independent Display capability (DVI-D + DVI-I outputs)		Intel® Graphics Media Accelerator 3100 with Dual-Independent Display capability (VGA + DVI-D outputs)	
Graphics Connector	PCI Express* x16		N/A		PCI Express* x16	
Memory Support	DDR2 800 / 667 SDRAM 4 slots, Dual-channel (8 GB <sup>2</sup> max)		DDR2 800 / 667 SDRAM 4 slots, Dual-channel (4 GB <sup>2</sup> max)		DDR2 800 / 667 SDRAM 4 slots, Dual-channel (8 GB <sup>2</sup> max)	
Expansion Slots	2 PCI Express x1, 1 PCI		1 PCI Express*		2 PCI Express x1, 1 PCI	
Audio	Intel® High Definition Audio: 6-channel codec		Intel® High Definition Audio: 6-channel codec		Intel® High Definition Audio: 4-channel codec	
USB Ports	12 Hi-Speed USB 2.0, 6 external ports / 6 ports via 3 internal headers		10 Hi-Speed USB 2.0, 6 external ports / 4 ports via 3 internal headers		12 Hi-Speed USB 2.0, 6 external ports / 6 ports via 3 internal headers	
1394	Up to 2 IEEE 1394a ports (1 back port, 1 via internal header)		N/A		Up to 2 IEEE 1394a ports (1 back port, 1 via internal header)	
Storage	5-port SATA (3.0 Gb/s) with port multiplier and 1-port eSATA		4-port SATA (3.0 Gb/s) with port multiplier and 1-port eSATA		6-port SATA (3.0 Gb/s) with port multiplier and 1-port eSATA Parallel ATA 100/66 port	
RAID	Intel® Matrix Storage Technology (RAID 0, 1, 5, 10, with Intel® Rapid Recover Technology)		Intel® Matrix Storage Technology (RAID 0, 1, 5, 10, with Intel® Rapid Recover Technology)		Intel® Matrix Storage Technology (RAID 0, 1, 5, 10, with Intel® Rapid Recover Technology)	
Onboard LAN	Intel® PRO 10/100/1000 Network Connection		Intel® PRO 10/100/1000 Network Connection		Intel® PRO 10/100/1000 Network Connection Intel® Active Management Technology (Intel® AMT) <sup>2</sup> with System Defense Feature	
TPM	No		No		Trusted Platform Module 1.2 Intel® Trusted Execution Technology Ready	
Lead Free	Yes		Yes		Yes	
Software	Intel® Integrator Assistant Intel® System Defense Utility Acronis® True Image 11 Home Diskeeper® Home Edition Laplink® PCmover® Express Norton® 360 TypePad* Kaspersky® Anti-Virus <sup>3</sup>	Kingsoft® AntiVirus <sup>4</sup> Kingsoft® Powerword <sup>44</sup>	Intel® Integrator Assistant Intel® System Defense Utility Acronis® True Image 11 Home Diskeeper® Home Edition Laplink® PCmover® Express Norton® 360 TypePad* Kaspersky® Anti-Virus <sup>3</sup>	Kingsoft® AntiVirus <sup>4</sup> Kingsoft® Powerword <sup>44</sup>	Intel® Audio Studio Intel® Desktop Utilities Intel® Integrator Assistant Intel® Integrator Toolkit Diskeeper® 9 Home Edition FarStone® RestoreIT* Norton® 360 Norton AntiVirus*	Premium VoIP Service Offers SAAZ® Starter Edition 5.0 SyAM® Software Desktop Monitor Central Wave® EMBASSY® Trust Suite Kaspersky® Anti-Virus <sup>3</sup> Kingsoft® Antivirus <sup>4</sup>
Intel® Advanced BIOS	Intel® Express BIOS Update Intel® Platform Innovation Framework for the Extensible Firmware Interface (EFI) Intel® Quiet System Technology	Digital Signature Technology Fault Tolerant Flashing Multiple Language Support	Intel® Express BIOS Update Intel® Platform Innovation Framework for the Extensible Firmware Interface (EFI) Intel® Quiet System Technology	Digital Signature Technology Fault Tolerant Flashing Multiple Language Support	Intel® Express BIOS Update Intel® Platform Innovation Framework for the Extensible Firmware Interface (EFI) Intel® Quiet System Technology	Digital Signature Technology Fault Tolerant Flashing Multiple Language Support
Windows Vista® and WHQL Support	Windows Vista® Premium		Windows Vista® Premium		Windows Vista® Premium	
Warranty	3 year limited warranty		3 year limited warranty		3 year limited warranty	



Series	Executive Series - Supports Intel® vPro™ Technology	Executive Series - Supports Intel® vPro™ Technology	Classic Series - Supports Intel® Platform Administration Technology	
<b>Product Family</b>	Intel® Desktop Board DQ35MP	Intel® Desktop Board DQ965GF	Intel® Desktop Board DG43NB	
<b>Form Factor</b>	MicroATX	MicroATX	ATX	
<b>Product Code/UPC</b>	<b>BOXDQ35MPE / 0073585888805</b>	<b>BOXDQ965GF EKR / 00735858180993</b>	<b>BOXDG43NB / 00735858201766</b>	
<b>10-pack Product Code/UPC</b>	BLKDQ35MPE / 00735858888803	BLKDQ965GF EKR / 00735858181006	BLKDG43NB / 00735858201773	
<b>Processor Support</b>	Intel® Core™2 Quad, Intel® Core™2 Duo, Intel® Pentium® Dual-Core, Intel® Celeron® Dual-Core, and Intel® Celeron® processors in the LGA775 package	Intel® Core™2 Quad <sup>6</sup> , Intel® Core™2 Duo, Intel® Pentium® Dual-Core, Intel® Celeron® Dual-Core, and Intel® Celeron® processors in the LGA775 package	Intel® Core™2 Quad, Intel® Core™2 Duo, Intel® Pentium® Dual-Core, Intel® Celeron® Dual-Core, and Intel® Celeron® processors in the LGA775 package	
<b>Supported FSB</b>	1333 MHz / 1066 MHz / 800 MHz	1066 MHz / 800 MHz / 533 MHz	1333 MHz / 1066 MHz / 800 MHz	
<b>Chipset</b>	Intel® Q35 Express Chipset with ICH9DO Intel® Active Management Technology Specification 3.0	Intel® Q965 Express Chipset	Intel® G43 Express Chipset	
<b>Supports HT Technology<sup>1</sup></b>	No	Yes	No	
<b>Graphics</b>	Intel® Graphics Media Accelerator 3100	Intel® Graphics Media Accelerator 3000	Intel® Graphics Media Accelerator X4500 with Dual-Independent Display capability (VGA + DVI-D outputs)	
<b>Graphics Connector</b>	PCI Express* x16	PCI Express* x16	PCI Express* x16	
<b>Memory Support</b>	DDR2 800 / 667 SDRAM 4 slots, Dual-channel (8 GB <sup>2</sup> max)	DDR2 800 / 667 / 533 <sup>7</sup> SDRAM, Dual-channel (8 GB <sup>2</sup> max)	DDR2 800 / 667 SDRAM 2 slots, Dual-channel (4 GB <sup>2</sup> max)	
<b>Expansion Slots</b>	2 PCI Express x1, 1 PCI	1 PCI Express x1, 2 PCI	3 PCI Express x1, 3 PCI	
<b>Audio</b>	Intel® High Definition Audio: 4-channel codec	Intel® High Definition Audio: 6-channel audio with jack sensing	Intel® High Definition Audio: 6-channel audio with jack sensing	
<b>USB Ports</b>	12 Hi-Speed USB 2.0, 6 external ports / 6 ports via 3 internal headers	10 Hi-Speed USB 2.0, 6 back ports / 4 ports via 2 internal headers	12 Hi-Speed USB 2.0, 6 back ports / 6 ports via 3 internal headers	
<b>1394</b>	N/A	Up to 2 IEEE 1394a ports (1 back port, 1 via internal header)	Up to 2 IEEE 1394a ports (1 back port, 1 via internal header)	
<b>Storage</b>	6-port SATA (3.0 Gb/s) with port multiplier and 1-port eSATA Parallel ATA 100/66 port	6-port SATA (3.0 Gb/s, NCQ, Hot Plug) and ATA 100/66 up to two devices	6-port SATA (3.0 Gb/s, NCQ, Hot Plug) and ATA 100/66 up to two devices	
<b>RAID</b>	Intel® Matrix Storage Technology (RAID 0, 1, 5, 10, with Intel® Rapid Recover Technology)	Intel® Matrix Storage Technology (RAID 0, 1, 5, 10, and Matrix RAID)	No	
<b>Onboard LAN</b>	Intel® PRO 10/100/1000 Network Connection Intel® Active Management Technology (Intel® AMT) <sup>5</sup> with System Defense Feature	Intel® PRO 10/100/1000 Network Connection Intel® Active Management Technology (Intel® AMT) <sup>5</sup> with System Defense Feature	Intel® PRO 10/100/1000 Network Connection	
<b>TPM</b>	Trusted Platform Module 1.2 Intel® Trusted Execution Technology Ready	Trusted Platform Module 1.2	No	
<b>Lead Free</b>	Yes	Yes	Yes	
<b>Software</b>	Intel® Audio Studio Intel® Desktop Utilities Intel® Integrator Assistant Intel® Integrator Toolkit Diskeeper* 9 Home Edition FarStone* RestoreIT* Norton* 360 Norton AntiVirus*	Premium VoIP Service Offers SAAZ* Starter Edition 5.0 SyAM* Software Desktop Monitor Central Wave* EMBASSY* Trust Suite Kaspersky* Anti-Virus <sup>3</sup> Kingsoft* Antivirus <sup>4</sup>	Intel® Audio Studio SAAZ* Starter Edition 5.0 SyAM* Software Desktop Monitor Central Wave* EMBASSY* Trust Suite Kaspersky* Anti-Virus <sup>3</sup> Kingsoft* Antivirus <sup>4</sup>	Intel® Integrator Assistant Skype* Intel® Platform Administration TypePad* Technology WildTangent* Acronis* True Image OEM Kaspersky* Anti-Virus <sup>3</sup> Diskeeper* Home Edition Kingsoft* Antivirus <sup>4</sup> DivX* for Windows* Kingsoft* Powerword* <sup>4</sup> Laplink* PCmover* Express Norton Internet Security*
<b>Intel® Advanced BIOS</b>	Intel® Express BIOS Update Intel® Platform Innovation Framework for the Extensible Firmware Interface (EFI) Intel® Quiet System Technology	Intel® Express BIOS Update Intel® Platform Innovation Framework for the Extensible Firmware Interface (EFI) Intel® Quiet System Technology	Intel® Express BIOS Update Intel® Platform Innovation Framework for the Extensible Firmware Interface (EFI) Intel® Quiet System Technology	
<b>Windows Vista* and WHQL Support</b>	Windows Vista* Premium	Windows Vista* Premium	Windows Vista* Premium	
<b>Warranty</b>	3 year limited warranty	3 year limited warranty	3 year limited warranty	



Series	Classic Series - Supports Intel® Platform Administration Technology	Classic Series - Supports Intel® Platform Administration Technology	Classic Series - Supports Intel® Platform Administration Technology
<b>Product Family</b>	Intel® Desktop Board DG41TY	Intel® Desktop Board DP43TF	Intel® Desktop Board DG35EC
<b>Form Factor</b>	MicroATX	ATX	MicroATX
<b>Product Code/UPC</b>	<b>BOXDG41TY / 00735858204392</b>	<b>BOXDP43TF / 00735858202046</b>	<b>BOXDG35EC / 00735858200448</b>
<b>10-pack Product Code/UPC</b>	BLKDG41TY / 00735858204385	BLKDP43TF / 00735858202053	BLKDG35EC / 00735858200455
<b>Processor Support</b>	Intel® Core™2 Quad, Intel® Core™2 Duo, Intel® Pentium® Dual-Core, Intel® Celeron® Dual-Core, and Intel® Celeron® processors in the LGA775 package	Intel® Core™2 Quad, Intel® Core™2 Duo, Intel® Pentium® Dual-Core, Intel® Celeron® Dual-Core, and Intel® Celeron® processors in the LGA775 package	Intel® Core™2 Quad, Intel® Core™2 Duo, Intel® Pentium® Dual-Core, Intel® Celeron® Dual-Core, and Intel® Celeron® processors in the LGA775 package
<b>Supported FSB</b>	1333 MHz / 1066 MHz / 800 MHz	1333 MHz / 1066 MHz / 800 MHz	1333 MHz / 1066 MHz / 800 MHz
<b>Chipset</b>	Intel® G41 Express Chipset	Intel® P43 Express Chipset	Intel® G35 Express Chipset
<b>Supports HT Technology<sup>1</sup></b>	No	No	No
<b>Graphics</b>	Intel® Graphics Media Accelerator X4500 with Dual-Independent Display capability (VGA + DVI-D outputs)	None	Intel® Graphics Media Accelerator X3500 with Dual-Independent Display capability (VGA + DVI-D outputs)
<b>Graphics Connector</b>	PCI Express* x16	PCI Express* x16	PCI Express* x16
<b>Memory Support</b>	DDR2 800 / 667 SDRAM 2 slots, Dual-channel (8 GB <sup>2</sup> max)	DDR2 800 / 667 SDRAM 4 slots, Dual-channel (8 GB <sup>2</sup> max)	DDR2 800 / 667 SDRAM 4 slots, Dual-channel (8 GB <sup>2</sup> max)
<b>Expansion Slots</b>	1 PCI Express x1, 2 PCI	3 PCI Express x1, 3 PCI	2 PCI Express x1, 1 PCI
<b>Audio</b>	Intel® High Definition Audio: 6-channel audio with jack sensing	Intel® High Definition Audio: 6-channel audio with jack sensing	Intel® High Definition Audio: 6-channel audio with jack sensing
<b>USB Ports</b>	8 Hi-Speed USB 2.0, 4 back ports / 4 ports via 2 internal headers	12 Hi-Speed USB 2.0, 6 back ports / 6 ports via 3 internal headers	10 Hi-Speed USB 2.0, 6 back ports / 4 ports via 2 internal headers
<b>1394</b>	No	Up to 2 IEEE 1394a ports (1 back port, 1 via internal header)	Up to 2 IEEE 1394a ports (1 back port, 1 via internal header)
<b>Storage</b>	4-port SATA (3.0 Gb/s, NCQ, Hot Plug) and ATA 100/66 up to two devices	6-port SATA (3.0 Gb/s, NCQ, Hot Plug) and ATA 100/66 up to two devices	4-port SATA (3.0 Gb/s, NCQ, Hot Plug) and ATA 100/66 up to two devices
<b>RAID</b>	No	No	No
<b>Onboard LAN</b>	Realtek* Gigabit Ethernet Controller RTL 8111D	Intel® PRO 10/100/1000 Network Connection	Intel® PRO 10/100/1000 Network Connection
<b>TPM</b>	No	No	No
<b>Lead Free</b>	Yes	Yes	Yes
<b>Software</b>	Intel® Integrator Assistant Intel® Platform Administration Technology Acronis* True Image OEM Diskeeper* Home Edition DivX* for Windows Laplink* PCmover* Express Norton Internet Security* Skype* TypePad*	WildTangent* Kaspersky* Anti-Virus <sup>3</sup> Kingsoft* Antivirus <sup>4</sup> Kingsoft* Powerword <sup>4</sup>	Intel® Integrator Assistant Intel® Platform Administration Technology Acronis* True Image OEM Diskeeper* Home Edition DivX* for Windows Laplink* PCmover* Express Norton Internet Security* Skype* TypePad*
<b>Intel® Advanced BIOS</b>	Intel® Express BIOS Update Intel® Platform Innovation Framework for the Extensible Firmware Interface (EFI) Intel® Rapid BIOS Boot Digital Signature Technology Fault Tolerant Flashing Multiple Language Support	Intel® Express BIOS Update Intel® Platform Innovation Framework for the Extensible Firmware Interface (EFI) Intel® Quiet System Technology Intel® Rapid BIOS Boot Digital Signature Technology Fault Tolerant Flashing Multiple Language Support	Intel® Express BIOS Update Intel® Platform Innovation Framework for the Extensible Firmware Interface (EFI) Intel® Rapid BIOS Boot Digital Signature Technology Fault Tolerant Flashing Multiple Language Support
<b>Windows Vista* and WHQL Support</b>	Windows Vista* Premium	Windows Vista* Premium	Windows Vista* Premium
<b>Warranty</b>	3 year limited warranty	3 year limited warranty	3 year limited warranty



Series	Classic Series - Supports Intel® Platform Administration Technology	Classic Series - Supports Intel® Platform Administration Technology	Classic Series - Supports Intel® Platform Administration Technology
<b>Product Family</b>	Intel® Desktop Board DG33FB	Intel® Desktop Board DG33BU	Intel® Desktop Boards DG31PR
<b>Form Factor</b>	ATX	MicroATX	MicroATX
<b>Product Code/UPC</b>	<b>BOXDG33FBC / 00735858192064</b>	<b>BOXDG33BUC / 00735858192095</b>	<b>BOXDG31PRC / 00735858891347</b>
<b>10-pack Product Code/UPC</b>	BLKDG33FBC / 00735858192071	BLKDG33BUC / 00735858192101	BLKDG31PR / 00735858891348
<b>Processor Support</b>	Intel® Core™2 Quad (95W TDP), Intel® Core™2 Duo, Intel® Pentium® Dual-Core, Intel® Celeron® Dual-Core, and Intel® Celeron® processors in the LGA775 package	Intel® Core™2 Quad (95W TDP), Intel® Core™2 Duo, Intel® Pentium® Dual-Core, Intel® Celeron® Dual-Core, and Intel® Celeron® processors in the LGA775 package	Intel® Core™2 Quad (95W TDP), Intel® Core™2 Duo, Intel® Pentium® Dual-Core, Intel® Celeron® Dual-Core, and Intel® Celeron® processors in the LGA775 package
<b>Supported FSB</b>	1333 MHz / 1066 MHz / 800 MHz	1333 MHz / 1066 MHz / 800 MHz	1333 MHz / 1066 MHz / 800 MHz
<b>Chipset</b>	Intel® G33 Express Chipset (refer to the Desktop Platforms Matrix)	Intel® G33 Express Chipset (refer to the Desktop Platforms Matrix)	Intel® G31 Express Chipset with ICH7
<b>Supports HT Technology<sup>1</sup></b>	Yes	Yes	Yes
<b>Graphics</b>	Intel® Graphics Media Accelerator 3100 with Intel® Clear Video Technology	Intel® Graphics Media Accelerator 3100 with Intel® Clear Video Technology	Intel® Graphics Media Accelerator 3100
<b>Graphics Connector</b>	PCI Express* x16	PCI Express* x16	PCI Express* x16
<b>Memory Support</b>	DDR2 800 / 667 SDRAM 4 slots, Dual-channel (8 GB <sup>2</sup> max)	DDR2 800 / 667 SDRAM 4 slots, Dual-channel (8 GB <sup>2</sup> max)	DDR2 800 / 667 SDRAM 2 slots, Dual-channel (4 GB <sup>2</sup> max)
<b>Expansion Slots</b>	3 PCI Express x1, 3 PCI	1 PCI Express x1, 2 PCI	1 PCI Express x1, 2 PCI
<b>Audio</b>	Intel® High Definition Audio: 6-channel audio with jack sensing	Intel® High Definition Audio: 6-channel audio with jack sensing	Intel® High Definition Audio: 6-channel audio with jack sensing Front panel mic/headphone header
<b>USB Ports</b>	12 Hi-Speed USB 2.0, 6 back ports / 6 ports via 3 internal headers	12 Hi-Speed USB 2.0, 6 back ports / 6 ports via 3 internal headers	8 Hi-Speed USB 2.0, 4 external ports / 4 ports via 2 internal headers
<b>1394</b>	Up to 2 IEEE 1394a ports (1 back port, 1 via internal header)	Up to 2 IEEE 1394a ports (1 back port, 1 via internal header)	N/A
<b>Storage</b>	4-port SATA (3.0 Gb/s) and ATA 100/66 up to two devices	4-port SATA (3.0 Gb/s) and ATA 100/66 up to two devices	4-port SATA (3.0 Gb/s) and 1-port Parallel ATA up to two devices
<b>RAID</b>	No	No	No
<b>Onboard LAN</b>	Intel® PRO 10/100/1000 Network Connection	Intel® PRO 10/100/1000 Network Connection	Integrated 10/100/1000 Network Connection
<b>TPM</b>	No	No	No
<b>Lead Free</b>	Yes	Yes	Yes
<b>Software</b>	Intel® Desktop Utilities Intel® Integrator Assistant Intel® Integrator Toolkit Diskeeper® Home Edition Norton Internet Security* Skype* TypePad* Kaspersky® Anti-Virus <sup>3</sup> Kingsoft® Antivirus <sup>4</sup>	Intel® Desktop Utilities Intel® Integrator Assistant Intel® Integrator Toolkit Diskeeper® Home Edition Norton Internet Security* Skype* TypePad* Kaspersky® Anti-Virus <sup>3</sup> Kingsoft® Antivirus <sup>4</sup>	Intel® Integrator Assistant Intel® Integrator Toolkit Diskeeper® Home Edition Norton Internet Security* Skype* TypePad* Kaspersky® Anti-Virus <sup>3</sup> Kingsoft® Antivirus <sup>4</sup>
<b>Intel® Advanced BIOS</b>	Intel® Express BIOS Update Intel® Platform Innovation Framework for the Extensible Firmware Interface (EFI) Intel® Quiet System Technology Intel® Rapid BIOS Boot Digital Signature Technology Fault Tolerant Flashing Multiple Language Support	Intel® Express BIOS Update Intel® Platform Innovation Framework for the Extensible Firmware Interface (EFI) Intel® Quiet System Technology Intel® Rapid BIOS Boot Digital Signature Technology Fault Tolerant Flashing Multiple Language Support	Intel® Express BIOS Update Intel® Platform Innovation Framework for the Extensible Firmware Interface (EFI) Intel® Rapid BIOS Boot Digital Signature Technology Fault Tolerant Flashing Multiple Language Support
<b>Windows Vista® and WHQL Support</b>	Windows Vista® Premium	Windows Vista® Premium	Windows Vista® Premium
<b>Warranty</b>	3 year limited warranty	3 year limited warranty	3 year limited warranty



<b>Series</b>	Essential Series - Supports Intel® Platform Administration Technology	Essential Series - Supports Intel® Platform Administration Technology	Essential Series - Supports Intel® Platform Administration Technology
<b>Product Family</b>	Intel® Desktop Board D945GCLF2	Intel® Desktop Board D945GCLF	Intel® Desktop Board D945GCPE
<b>Form Factor</b>	Mini-ITX, MicroATX-compatible	Mini-ITX, MicroATX-compatible	MicroATX
<b>Product Code/UPC</b>	BOXD945GCLF2 / 00735858201278	BOXD945GCLF / 00735858201247	BOXD945GCPE / 00735858891246
<b>10-pack Product Code/UPC</b>	BLKD945GCLF2 / 00735858201285	BLKD945GCLF / 00735858201254	BLKD945GCPE / 00735858891247
<b>Processor Support</b>	Intel® Atom™ Processor 330 integrated	Intel® Atom™ Processor 230 integrated in BGA package	Intel® Core™2 Duo, Intel® Pentium® Dual-Core, Intel® Celeron® Dual-Core, and Intel® Celeron® processors in the LGA775 package
<b>Supported FSB</b>	533 MHz	533 MHz	1066 MHz / 800 MHz
<b>Chipset</b>	Intel® 945GC Express Chipset with ICH7	Intel® 945GC Express Chipset with ICH7	Intel® 945GC Express Chipset with ICH7
<b>Supports HT Technology<sup>1</sup></b>	No	No	Yes
<b>Graphics</b>	Intel® Graphics Media Accelerator 950	Intel® Graphics Media Accelerator 950	Intel® Graphics Media Accelerator 950
<b>Graphics Connector</b>	N/A	N/A	N/A
<b>Memory Support</b>	DDR2 667 / 533 SDRAM 1 slot, Single-channel (2 GB max)	DDR2 667 / 533 SDRAM 1 slot, Single-channel (2 GB max)	DDR2 667 / 533 SDRAM 2 slots, Dual-channel (2 GB max)
<b>Expansion Slots</b>	1 PCI	1 PCI	2 PCI
<b>Audio</b>	6-channel audio (with multi-streaming support)	4-channel audio (with multi-streaming support)	High Definition Audio: 4-channel audio, Front panel mic/headphone header
<b>USB Ports</b>	8 Hi-Speed USB 2.0, 4 back ports / 4 ports via 2 internal headers	6 Hi-Speed USB 2.0, 4 back ports / 2 ports via 1 internal header	8 Hi-Speed USB 2.0, 4 external ports / 4 ports via 2 internal headers
<b>1394</b>	N/A	N/A	N/A
<b>Storage</b>	2-port SATA and ATA 100 up to two devices	2-port SATA and ATA 100 up to two devices	2-port SATA (3.0 Gb/s) and 1-port Parallel ATA up to two devices
<b>RAID</b>	No	No	No
<b>Onboard LAN</b>	Realtek® 10/100/1000 Network Connection	Realtek® 10/100 Network Connection	Integrated 10/100 Network Connection
<b>TPM</b>	No	No	No
<b>Lead Free</b>	Yes	Yes	Yes
<b>Software</b>	Intel® Integrator Assistant Intel® Integrator Toolkit Intel® Platform Administration Technology Diskeeper® Home Edition Norton Internet Security* Skype® TypePad® Kaspersky® Anti-Virus <sup>3</sup> Kingsoft® Antivirus <sup>4</sup>	Intel® Integrator Assistant Intel® Integrator Toolkit Diskeeper® Home Edition Norton Internet Security* Skype® TypePad® Kaspersky® Anti-Virus <sup>3</sup> Kingsoft® Antivirus <sup>4</sup>	Intel® Integrator Assistant Intel® Integrator Toolkit Diskeeper® Home Edition Norton Internet Security* Skype® TypePad® Kaspersky® Anti-Virus <sup>3</sup> Kingsoft® Antivirus <sup>4</sup>
<b>Intel® Advanced BIOS</b>	Intel® Express BIOS Update Intel® Rapid BIOS Boot	Intel® Express BIOS Update Intel® Rapid BIOS Boot	Intel® Express BIOS Update Intel® Platform Innovation Framework for the Extensible Firmware Interface (EFI) Intel® Rapid BIOS Boot Digital Signature Technology Fault Tolerant Flashing Multiple Language Support
<b>Windows Vista® and WHQL Support</b>	Windows Vista® Basic	Windows Vista® Basic	Windows Vista® Premium
<b>Warranty</b>	3 year limited warranty	3 year limited warranty	3 year limited warranty



<b>Series</b>	<b>Essential Series</b> - Supports Intel® Platform Administration Technology	<b>Essential Series</b> - Supports Intel® Platform Administration Technology
<b>Product Family</b>	<b>Intel® Desktop Board DG31GL</b>	<b>Intel® Desktop Board D945GCNL</b>
<b>Form Factor</b>	MicroATX	MicroATX
<b>Product Code/UPC</b>	<b>BOXDG31GL / 00735858200929</b>	<b>BOXD945GCNL / 00735858891241</b>
<b>10-pack Product Code/UPC</b>	BLKDG31GL / 00735858200936	BLKD945GCNL / 00735858891242
<b>Processor Support</b>	<b>Intel® Core™2 Quad, Intel® Core™2 Duo, Intel® Pentium® Dual-Core, Intel® Celeron® Dual-Core, and Intel® Celeron® processors in the LGA775 package</b>	<b>Intel® Core™2 Duo, Intel® Pentium® Dual-Core, Intel® Celeron® Dual-Core, and Intel® Celeron® processors in the LGA775 package</b>
<b>Supported FSB</b>	1333 MHz / 1066 MHz / 800 MHz	1066 MHz / 800 MHz
<b>Chipset</b>	Intel® G31 Express Chipset	Intel® 945GC Express Chipset with ICH7
<b>Supports HT Technology<sup>1</sup></b>	No	Yes
<b>Graphics</b>	Intel® Graphics Media Accelerator 3100	Intel® Graphics Media Accelerator 950
<b>Graphics Connector</b>	N/A	PCI Express* x16
<b>Memory Support</b>	DDR2 800 / 667 SDRAM 4 slots, Dual-channel (4 GB <sup>2</sup> max)	DDR2 667 / 533 SDRAM 2 slots, Dual-channel (2 GB max)
<b>Expansion Slots</b>	2 PCI	1 PCI Express x1, 2 PCI
<b>Audio</b>	Intel® High Definition Audio: 4-channel audio	Realtek* ALC 888 High Definition Audio: 6-channel (5.1), Front panel mic/headphone header
<b>USB Ports</b>	8 Hi-Speed USB 2.0, 4 back ports / 4 ports via 2 internal headers	8 Hi-Speed USB 2.0, 4 external ports / 4 ports via 2 internal headers
<b>1394</b>	N/A	N/A
<b>Storage</b>	4-port SATA (3.0 Gb/s, NCQ, Hot Plug) and ATA 100/66 up to two devices	4-port SATA (3.0 Gb/s) and 1-port Parallel ATA up to two devices
<b>RAID</b>	No	No
<b>Onboard LAN</b>	Intel® PRO 10/100 Network Connection	Integrated 10/100/1000 Network Connection
<b>TPM</b>	No	No
<b>Lead Free</b>	Yes	Yes
<b>Software</b>	Intel® Integrator Assistant Intel® Integrator Toolkit Diskeeper* Home Edition Norton Internet Security* Skype* TypePad* Kaspersky* Anti-Virus <sup>3</sup> Kingsoft* Antivirus <sup>4</sup>	Intel® Integrator Assistant Intel® Integrator Toolkit Intel® Platform Administration Technology Diskeeper* Home Edition Norton Internet Security* Skype* TypePad* Kaspersky* Anti-Virus <sup>3</sup> Kingsoft* Antivirus <sup>4</sup>
<b>Intel® Advanced BIOS</b>	Intel® Express BIOS Update Intel® Platform Innovation Framework for the Extensible Firmware Interface (EFI) Intel® Rapid BIOS Boot Digital Signature Technology Fault Tolerant Flashing Multiple Language Support	Intel® Express BIOS Update Intel® Platform Innovation Framework for the Extensible Firmware Interface (EFI) Intel® Rapid BIOS Boot Digital Signature Technology Fault Tolerant Flashing Multiple Language Support
<b>Windows Vista* and WHQL Support</b>	Windows Vista* Basic	Windows Vista* Premium
<b>Warranty</b>	3 year limited warranty	3 year limited warranty

INTEL® DESKTOP ADAPTERS

10/100/1000 Mb/s-OVER-COPPER



10/100 Mb/s-OVER-COPPER



Product Code—Singles

Product Code—  
Bulk Twenty Packs  
(Full-Height End-Brackets)

Product Code—  
Bulk Twenty Packs  
(Low-Profile End Brackets)

Connector

Ethernet Controllers

Bus Width and Type

	Intel® Gigabit CT Desktop Adapter	Intel® PRO/1000 PT Desktop Adapter	Intel® PRO/1000 GT Desktop Adapter	Intel® PRO/100 S Desktop Adapter-w/3DES (168-bit)	Intel® PRO/100 M Desktop Adapter
Product Code—Singles	EXPI9301CT	EXPI9300PT	PWLA8391GT	PILA8460C3	PILA8460M
Product Code— Bulk Twenty Packs (Full-Height End-Brackets)	EXPI9301CTBLK <sup>8</sup>	EXPI9300PTBLK	PWLA8391GTBLK	PILA8460C3BLK	PILA8460MBLK20
Product Code— Bulk Twenty Packs (Low-Profile End Brackets)	EXPI9301CTBLK <sup>8</sup>	EXPI9300PTLPBLK	PWLA8391GTLBLK	N/A	N/A
Connector	1 RJ-45	1 RJ-45	1 RJ-45	1 RJ-45	1 RJ-45
Ethernet Controllers	Intel® 82574L	Intel® 82572GI	Intel® 82541PI	Intel® 82550EY	Intel® 82551QM
Bus Width and Type	PCI Express* x1	PCI Express* x1	32-bit PCI 2.3	32-bit PCI 2.2	32-bit PCI 2.2

For more information, visit the Intel Web site at: [www.intel.com/network/connectivity/index.htm](http://www.intel.com/network/connectivity/index.htm)

<sup>1</sup> Hyper-Threading Technology requires a computer system with a processor supporting HT Technology and an HT Technology-enabled chipset, BIOS, and operating system. Performance will vary depending on the specific hardware and software you use. For more information including details on which processors support HT Technology, see [www.intel.com/info/hyperthreading](http://www.intel.com/info/hyperthreading).

<sup>2</sup> System resources and hardware (such as PCI and PCI Express\*) require physical memory address locations that can reduce available addressable system memory. This could result in a reduction of as much as 1 GB or more of physical addressable memory being available to the operating system and applications, depending on the system configuration and operating system.

<sup>3</sup> Russian only

<sup>4</sup> Chinese only

<sup>5</sup> Intel® AMT requires the computer to have an Intel® AMT-enabled chipset, network hardware and software, connection with a power source, and a network connection.

<sup>6</sup> May require latest board revision, visit [www.intel.com/products/desktop/motherboard/index.htm](http://www.intel.com/products/desktop/motherboard/index.htm) for more information.

<sup>7</sup> In combination with Intel® processors in the LGA775 package with 800 MHz and 533 MHz system bus.

<sup>8</sup> Full-height bracket installed, low-profile bracket added in package.

Intel® desktop boards may contain design defects or errors known as errata, which may cause the product to deviate from published specifications. Current characterized errata are available on request. All products and dates specified are preliminary based on current expectations and are subject to change without notice. Availability in different channels may vary.

Intel, the Intel logo, Intel Viiiv, Intel vPro, Intel Core, Core Inside, Xeon, Pentium, Pentium Inside, Celeron, Celeron Inside, Intel Atom, and Intel Atom Inside are trademarks of Intel Corporation in the U.S. and other countries.

\* Other names and brands may be claimed as the property of others.

Copyright © 2008 Intel Corporation. All rights reserved. 1008/RR/MS Part number: 252642-027US October 2008



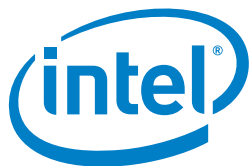

# Intel® Graphics Product Matrix— Desktop Products



## Intel® Graphics—also great for business!

- Full support for Windows Vista\* Premium
- Cost efficient and lower power (no need for a separate graphics card)
- Enables the use of dual-independent displays

	INTEL® GRAPHICS CORE NAME	ASSOCIATED INTEL® EXPRESS CHIPSET	BENEFITS	VIDEO MEMORY	HD VIDEO PLAYBACK	VIDEO SHARPNESS/DETAIL/COLOR	3D SUPPORT	DISPLAY INTERFACE SUPPORT	WINDOWS VISTA* SUPPORT
<b>Best</b>	Intel® Graphics Media Accelerator X4500HD	G45	Superior video quality and performance, supporting full Blu-ray* playback. 3D enhancements enable improved realism with support for Microsoft DirectX* 10.	Up to 829 MB <sup>1</sup>	<ul style="list-style-type: none"> <li>▪ 1080p, 1080i, and 720p</li> <li>▪ Native support for full Blu-ray* playback</li> </ul>	<ul style="list-style-type: none"> <li>▪ Advanced De-Interlacing (HD and SD)</li> <li>▪ Sharpness / Detail Filter</li> <li>▪ Cadence Detection</li> </ul>	<ul style="list-style-type: none"> <li>▪ DirectX* 10</li> <li>▪ Shader Model 4.0</li> <li>▪ OpenGL* 2.0</li> </ul>	<ul style="list-style-type: none"> <li>▪ DisplayPort*</li> <li>▪ Integrated HDMI, DVI, and S-Video</li> <li>▪ Intel® TV Tuner Wizard</li> <li>▪ Dual-Independent Display</li> </ul>	<ul style="list-style-type: none"> <li>▪ Ultimate</li> <li>▪ Home Premium</li> <li>▪ Enterprise</li> <li>▪ Basic</li> </ul>
<b>Better</b>	Intel® Graphics Media Accelerator X4500	G43	Exceptional HD playback performance. Improved 3D gaming with support for Microsoft DirectX* 10.	Up to 829 MB <sup>1</sup>	<ul style="list-style-type: none"> <li>▪ 1080p, 1080i, and 720p</li> <li>▪ Support for Blu-ray* playback</li> </ul>	<ul style="list-style-type: none"> <li>▪ Adaptive De-Interlacing</li> </ul>	<ul style="list-style-type: none"> <li>▪ DirectX* 10</li> <li>▪ Shader Model 4.0</li> <li>▪ OpenGL* 2.0</li> </ul>	<ul style="list-style-type: none"> <li>▪ DisplayPort*</li> <li>▪ Integrated HDMI, DVI, and S-Video</li> <li>▪ Intel® TV Tuner Wizard</li> <li>▪ Dual-Independent Display</li> </ul>	<ul style="list-style-type: none"> <li>▪ Ultimate</li> <li>▪ Home Premium</li> <li>▪ Enterprise</li> <li>▪ Basic</li> </ul>
<b>Good</b>	Intel® Graphics Media Accelerator X3500	G35	Excellent video quality and performance, supporting the latest in HD playback. Improved 3D gaming with support for Microsoft DirectX* 10.	Up to 384 MB	<ul style="list-style-type: none"> <li>▪ 1080p, 1080i, and 720p</li> <li>▪ Support for Blu-ray* playback</li> </ul>	<ul style="list-style-type: none"> <li>▪ Advanced De-Interlacing</li> <li>▪ Sharpness / Detail Filter</li> </ul>	<ul style="list-style-type: none"> <li>▪ DirectX* 10</li> <li>▪ Shader Model 4.0</li> <li>▪ OpenGL* 2.0</li> </ul>	<ul style="list-style-type: none"> <li>▪ HDMI, DVI, and S-Video</li> <li>▪ Intel® TV Tuner Wizard</li> <li>▪ Dual-Independent Display</li> </ul>	<ul style="list-style-type: none"> <li>▪ Ultimate</li> <li>▪ Home Premium</li> <li>▪ Enterprise</li> <li>▪ Basic</li> </ul>
<b>Entry</b>	Intel® Graphics Media Accelerator 3100	G31	Good HD playback performance. Improved 3D gaming with support for Shader Model 2.0.	Up to 256 MB	<ul style="list-style-type: none"> <li>▪ 1080p, 1080i, and 720p</li> </ul>	<ul style="list-style-type: none"> <li>▪ Adaptive De-Interlacing</li> </ul>	<ul style="list-style-type: none"> <li>▪ DirectX* 9.0c</li> <li>▪ Shader Model 2.0</li> <li>▪ OpenGL* 1.4</li> </ul>	<ul style="list-style-type: none"> <li>▪ DVI and S-Video</li> <li>▪ Dual-Independent Display</li> </ul>	<ul style="list-style-type: none"> <li>▪ Ultimate</li> <li>▪ Home Premium</li> <li>▪ Enterprise</li> <li>▪ Basic</li> </ul>

Intel® Graphics are the #1 choice of personal computer buyers worldwide<sup>2</sup>, delivering smooth, high-quality HD video playback, advanced 3D capabilities, and full support for the Windows Vista\* operating system. Intel Graphics deliver a unique solution for a broad array of users without the costs typically associated with add-on graphics cards.

For more information, visit the Intel Web site at:  
[www.intel.com/go/graphics](http://www.intel.com/go/graphics)

# Intel® Graphics Product Matrix— Mobile Products



**Intel® Graphics—also great for business!**

- Full support for Windows Vista\* Premium
- Cost efficient and lower power, enabling longer battery life
- Enables the use of dual-independent displays

	INTEL® GRAPHICS CORE NAME	ASSOCIATED INTEL® EXPRESS CHIPSET(S)	BENEFITS	VIDEO MEMORY	HD VIDEO PLAYBACK	VIDEO SHARPNESS/ DETAIL/COLOR	3D SUPPORT	DISPLAY INTERFACE SUPPORT	INTEL® CENTRINO® DUO TECHNOLOGY
<b>Best</b>	Mobile Intel® Graphics Media Accelerator 4000M Series	GM45 GM47	Superior video quality and performance, supporting full Blu-ray* playback. 3D enhancements enable improved realism with support for Microsoft DirectX* 10.	Up to 829 MB <sup>1</sup>	<ul style="list-style-type: none"> <li>▪ 1080p, 1080i, and 720p</li> <li>▪ Native support for full Blu-ray* playback</li> </ul>	<ul style="list-style-type: none"> <li>▪ Advanced De-Interlacing</li> <li>▪ Sharpness / Detail Filter</li> <li>▪ Cadence Detection</li> </ul>	<ul style="list-style-type: none"> <li>▪ DirectX* 10</li> <li>▪ Shader Model 4.0</li> <li>▪ OpenGL* 2.0</li> </ul>	<ul style="list-style-type: none"> <li>▪ DisplayPort*</li> <li>▪ Integrated HDMI, DVI, and S-Video</li> <li>▪ Intel® TV Tuner Wizard</li> <li>▪ Dual-Independent Display</li> </ul>	Yes
<b>Small Form Factor</b>	Mobile Intel® Graphics Media Accelerator 4000M Series	GS45	Energy-efficient graphics performance for ultra-mobile PCs.	Up to 829 MB <sup>1</sup>	<ul style="list-style-type: none"> <li>▪ 1080p, 1080i, and 720p</li> <li>▪ Native support for full Blu-ray* playback</li> </ul>	<ul style="list-style-type: none"> <li>▪ Advanced De-Interlacing</li> <li>▪ Sharpness / Detail Filter</li> <li>▪ Cadence Detection</li> </ul>	<ul style="list-style-type: none"> <li>▪ DirectX* 10</li> <li>▪ Shader Model 4.0</li> <li>▪ OpenGL* 2.0</li> </ul>	<ul style="list-style-type: none"> <li>▪ DisplayPort*</li> <li>▪ Integrated HDMI, DVI, and S-Video</li> <li>▪ Intel® TV Tuner Wizard</li> <li>▪ Dual-Independent Display</li> </ul>	Yes
<b>Entry</b>	Mobile Intel® Graphics Media Accelerator 4000M Series	GL40	Great entry platform to meet all basic computing needs.	Up to 829 MB <sup>1</sup>	<ul style="list-style-type: none"> <li>▪ 1080p, 1080i, and 720p</li> <li>▪ Native support for full Blu-ray* playback</li> </ul>	<ul style="list-style-type: none"> <li>▪ Advanced De-Interlacing</li> <li>▪ Sharpness / Detail Filter</li> </ul>	<ul style="list-style-type: none"> <li>▪ DirectX* 10</li> <li>▪ Shader Model 4.0</li> <li>▪ OpenGL* 2.0</li> </ul>	<ul style="list-style-type: none"> <li>▪ HDMI, DVI, S-Video</li> <li>▪ Dual-Independent Display</li> </ul>	No (compatible with Intel® Celeron® and Intel® Pentium® processors only)

All of the mobile Intel® Graphics products above support Microsoft Windows Vista\* Ultimate, Home Premium, Enterprise, and Basic versions.

**Intel® Graphics are the #1 choice of personal computer buyers worldwide<sup>2</sup>, delivering smooth, high-quality HD video playback, advanced 3D capabilities, and full support for the Windows Vista\* operating system. Intel Graphics deliver a unique solution for a broad array of users without the costs typically associated with add-on graphics cards.**

<sup>1</sup> Supported on Windows Vista\* with 2 GB configuration  
<sup>2</sup> Mercury Research, PC Graphics 2008 (includes integrated and discrete graphics)  
 Intel, the Intel logo, Pentium, Celeron, and Centrino are trademarks of Intel Corporation in the U.S. and other countries.  
 \*Other names and brands may be claimed as the property of others.  
 Copyright © 2008 Intel Corporation. All rights reserved. 1008/RR/MS Part Number: 318716-004US **October 2008**

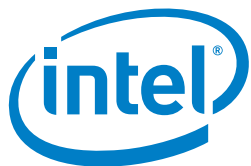

**INTEL® MOBILE PROCESSORS AND  
INTEL® PRO/WIRELESS NETWORK CONNECTIONS**

INTEL CONFIDENTIAL



PROCESSOR NAME	PRODUCT CODE	CLOCK SPEED	FRONT SIDE BUS	CACHE	PACKAGE/TYPE
Intel® Core™2 Extreme Processor QX9300	AW80581ZH061003 <i>(Tray Only)</i>	2.53 GHz	<b>1066 MHz</b>	12 MB L2	Socket-P (45nm)
Intel Core 2 Extreme Processor X9100	AW80576GH0836M <i>(Tray Only)</i>	3.06 GHz	<b>1066 MHz</b>	6 MB L2	Socket-P (45nm)
Intel Core 2 Extreme Processor X9000	FF80576ZG0726M <i>(Tray Only)</i>	2.80 GHz	800 MHz	6 MB L2	Socket-P (45nm)
PROCESSOR NAME	PRODUCT CODE	CLOCK SPEED	FRONT SIDE BUS	CACHE	PACKAGE/TYPE
Intel® Core™2 Quad Processor Q9100	AW80581GH051003 <i>(Tray Only)</i>	2.26 GHz	<b>1066 MHz</b>	12 MB L2	Socket-P (45nm)
PROCESSOR NAME	PRODUCT CODE	CLOCK SPEED	FRONT SIDE BUS	CACHE	PACKAGE/TYPE
Intel® Core™2 Duo Processor T9600	BX80576T9600	2.80 GHz	<b>1066 MHz</b>	6 MB L2	Socket-P (45nm)
Intel Core 2 Duo Processor T9400	BX80576T9400	2.53 GHz	<b>1066 MHz</b>	6 MB L2	Socket-P (45nm)
Intel Core 2 Duo Processor P9500	BX80576P9500	2.53 GHz	<b>1066 MHz</b>	6 MB L2	Socket-P (45nm)
Intel Core 2 Duo Processor P8600	BX80577P8600	2.40 GHz	<b>1066 MHz</b>	3 MB L2	Socket-P (45nm)
Intel Core 2 Duo Processor P8400	BX80577P8400	2.26 GHz	<b>1066 MHz</b>	3 MB L2	Socket-P (45nm)
Intel Core 2 Duo Processor T9500	FF80576GG0646M <i>(Tray Only)</i>	2.60 GHz	800 MHz	6 MB L2	Socket-P (45nm)
Intel Core 2 Duo Processor T9300	BX80576T9300	2.50 GHz	800 MHz	6 MB L2	Socket-P (45nm)
Intel Core 2 Duo Processor T8300	BX80577T8300	2.40 GHz	800 MHz	3 MB L2	Socket-P (45nm)
Intel Core 2 Duo Processor T8100	BX80577T8100	2.10 GHz	800 MHz	3 MB L2	Socket-P (45nm)
Intel Core 2 Duo Processor T7800	LF80537GG0644ML <i>(Tray Only)</i>	2.60 GHz	800 MHz	4 MB L2	Socket-P
Intel Core 2 Duo Processor T7700	BX80537T7700	2.40 GHz	800 MHz	4 MB L2	Socket-P
Intel Core 2 Duo Processor T7500	BX80537T7500	2.20 GHz	800 MHz	4 MB L2	Socket-P
Intel Core 2 Duo Processor T7250	BX80537T7250	2 GHz	800 MHz	2 MB L2	Socket-P
PROCESSOR NAME	PRODUCT CODE	CLOCK SPEED	FRONT SIDE BUS	CACHE	PACKAGE
Intel® Celeron® Processor 585	LF80537NF0481M <i>(Tray Only)</i>	2.16 GHz	<b>667 MHz</b>	1 MB L2	Socket-P
Intel Celeron Processor 575	LF80537NF0411M <i>(Tray Only)</i>	2 GHz	<b>667 MHz</b>	1 MB L2	Socket-P
Intel Celeron Processor 570	LF80537NE0511M <i>(Tray Only)</i>	2.26 GHz	533 MHz	1 MB L2	Socket-P
Intel Celeron Processor 560	BX80537560	2.13 GHz	533 MHz	1 MB L2	Socket-P
Intel Celeron Processor 550	BX80537550	2 GHz	533 MHz	1 MB L2	Socket-P

For more information, visit the Intel Web site at: [www.intel.com/go/notebooks](http://www.intel.com/go/notebooks)

## INTEL® PRO/WIRELESS NETWORK CONNECTIONS

PRODUCT NAME	PRODUCT CODE	WLAN STANDARD	FREQUENCY BAND	FORM FACTOR
<b>Intel® Wi-Fi* Link 5300</b> <i>(for the Intel® Centrino®2 with vPro™ processor)</i>	<b>533AN_MMWW2</b>	802.11a/b/g/n	2.401-2.492, 5.160-5.350, 5.470-5.725, 5.825-5.850 GHz	Mini Card
<b>Intel Wi-Fi Link 5300</b>	<b>533AN_MMWW</b>	802.11a/b/g/n	2.401-2.492, 5.160-5.350, 5.470-5.725, 5.825-5.850 GHz	Mini Card
<b>Intel Wi-Fi Link 5100</b> <i>(for the Intel® Centrino®2 with vPro™ processor)</i>	<b>512AN_MMWW2</b>	802.11a/b/g/n	2.401-2.492, 5.160-5.350, 5.470-5.725, 5.825-5.850 GHz	Mini Card
<b>Intel Wi-Fi Link 5100</b>	<b>512AN_MMWW</b>	802.11a/b/g/n	2.401-2.492, 5.160-5.350, 5.470-5.725, 5.825-5.850 GHz	Mini Card
<b>Intel® Next-Gen Wireless-N</b>	<b>4965AGNMM1WB</b>	802.11a/b/g/n	2.412-2.462, 5.18-5.32, 5.745-5.825 GHz	Mini Card
<b>Intel Next-Gen Wireless-N</b>	<b>4965AGNMM2WB</b>	802.11a/b/g/n	2.412-2.472, 5.18-5.24, 5.26-5.32, 5.50-5.70 GHz	Mini Card
<b>Intel Next-Gen Wireless-N</b>	<b>4965AGNMRWWB</b>	802.11a/b/g/n	2.412-2.472, 5.745-5.805 GHz	Mini Card
<b>Intel Next-Gen Wireless-N</b>	<b>4965AGNMJPWB</b>	802.11a/b/g/n	2.412-2.472, 5.17-5.23, 5.18-5.24, 5.26-5.32 GHz	Mini Card

For more information, visit the Intel Web site at: [www.intel.com/network/connectivity/products/wireless/index.htm](http://www.intel.com/network/connectivity/products/wireless/index.htm)

Intel processor numbers are not a measure of performance. Processor numbers differentiate features within each processor family, not across different processor families. See [www.intel.com/products/processor\\_number](http://www.intel.com/products/processor_number) for more details.

All products and dates specified are preliminary based on current expectations and are subject to change without notice. Availability in different channels may vary.

\*Other names and brands may be claimed as the property of others.

Intel, the Intel logo, Intel Core, Core Inside, Centrino, Intel vPro, Celeron, and Celeron Inside are trademarks of Intel Corporation in the U.S. and other countries.

Copyright © 2008 Intel Corporation. All rights reserved. 1008/RR/MS Part Number: 252630-024US **October 2008**

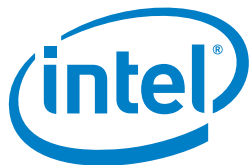

MULTI-CORE INTEL® XEON® PROCESSOR 3000 SEQUENCE

PROCESSOR NAME	PRODUCT CODE	CLOCK SPEED	FRONT SIDE BUS	CACHE	PACKAGE	# OF CPUS SUPPORTED	POWER	UPC CODE
Intel® Xeon® Processor X3370	BX80569X3370	3 GHz	1333 MHz	12 MB	LGA775	1	95 W	7 35858 20344 9
Intel Xeon Processor X3360	BX80569X3360	2.83 GHz	1333 MHz	12 MB	LGA775	1	95 W	7 35858 19986 5
Intel Xeon Processor X3350	BX80569X3350	2.66 GHz	1333 MHz	12 MB	LGA775	1	95 W	7 35858 19987 2
Intel Xeon Processor X3330	BX80569X3330	2.66 GHz	1333 MHz	6 MB	LGA775	1	95 W	7 35858 20343 2
Intel Xeon Processor X3320	BX80580X3320	2.50 GHz	1333 MHz	6 MB	LGA775	1	95 W	7 35858 19982 7
Intel Xeon Processor X3230	BX80562X3230	2.66 GHz	1066 MHz	8 MB	LGA775	1	95 W	7 35858 19537 9
Intel Xeon Processor X3220	BX80562X3220	2.40 GHz	1066 MHz	8 MB	LGA775	1	95 W	7 35858 19122 7
Intel Xeon Processor X3210	BX80562X3210	2.13 GHz	1066 MHz	8 MB	LGA775	1	95 W	7 35858 19123 4
Intel Xeon Processor E3120	BX80570E3120	3.16 GHz	1333 MHz	6 MB	LGA775	1	65 W	7 35858 20345 6
Intel Xeon Processor E3110	BX80570E3110	3 GHz	1333 MHz	6 MB	LGA775	1	65 W	7 35858 19983 4

Intel® Xeon® processors are the preferred choice for demanding server applications. Intel Xeon 5000 and 3000 sequence processors help to significantly improve compute power and response times for Internet applications, mail servers, small databases, and general purpose and technical computing applications, while the Multi-Core Intel Xeon 7000 sequence processors provide world-class performance for demanding enterprise-level applications.

For more information, visit the Intel Web site at: [www.intel.com/go/serverprocessors](http://www.intel.com/go/serverprocessors)

MULTI-CORE INTEL® XEON® PROCESSOR 5000 SEQUENCE

PROCESSOR NAME	PRODUCT CODE	CLOCK SPEED	FRONT SIDE BUS	CACHE	PACKAGE	# OF CPUS SUPPORTED	POWER	UPC CODE
Intel® Xeon® Processor X5492	AT80574KL096N <i>(tray only)</i>	3.40 GHz	<b>1600 MHz</b>	12 MB	LGA771	2	150 W	
Intel Xeon Processor X5482	AT80574KL088NT <i>(tray only)</i>	3.20 GHz	<b>1600 MHz</b>	12 MB	LGA771	2	120 W	
Intel Xeon Processor X5472	EU80574KL080NT <i>(tray only)</i>	3 GHz	<b>1600 MHz</b>	12 MB	LGA771	2	120 W	
Intel Xeon Processor E5472	EU80574KL080N <i>(tray only)</i>	3 GHz	<b>1600 MHz</b>	12 MB	LGA771	2	80 W	
Intel Xeon Processor E5462	EU80574KL072N <i>(tray only)</i>	2.80 GHz	<b>1600 MHz</b>	12 MB	LGA771	2	80 W	
Intel Xeon Processor X5470	BX80574X5470P <i>(2U passive heatsink)</i>	3.16 GHz	1333 MHz	12 MB	LGA771	2	120 W	7 35858 20374 6
	BX80574X5470A <i>(active or 1U heatsink)</i>	3.33 GHz	1333 MHz	12 MB	LGA771	2	120 W	7 35858 20373 9
Intel Xeon Processor X5460	BX80574X5460P <i>(2U passive heatsink)</i>	3.33 GHz	1333 MHz	12 MB	LGA771	2	120 W	7 35858 19880 6
	BX80574X5460A <i>(active or 1U heatsink)</i>	3.16 GHz	1333 MHz	12 MB	LGA771	2	120 W	7 35858 19879 0
Intel Xeon Processor X5450	BX80574X5450P <i>(2U passive heatsink)</i>	3 GHz	1333 MHz	12 MB	LGA771	2	120 W	7 35858 19882 0
	BX80574X5450A <i>(active or 1U heatsink)</i>	3 GHz	1333 MHz	12 MB	LGA771	2	120 W	7 35858 19881 3
Intel Xeon Processor E5450	BX80574E5450P <i>(2U passive heatsink)</i>	3 GHz	1333 MHz	12 MB	LGA771	2	80 W	7 35858 19884 4
	BX80574E5450A <i>(active or 1U heatsink)</i>	3 GHz	1333 MHz	12 MB	LGA771	2	80 W	7 35858 19883 7
Intel Xeon Processor E5440	BX80574E5440P <i>(2U passive heatsink)</i>	2.83 GHz	1333 MHz	12 MB	LGA771	2	80 W	7 35858 19886 8
	BX80574E5440A <i>(active or 1U heatsink)</i>	2.83 GHz	1333 MHz	12 MB	LGA771	2	80 W	7 35858 19885 1
Intel Xeon Processor E5430	BX80574E5430P <i>(2U passive heatsink)</i>	2.66 GHz	1333 MHz	12 MB	LGA771	2	80 W	7 35858 19888 2
	BX80574E5430A <i>(active or 1U heatsink)</i>	2.66 GHz	1333 MHz	12 MB	LGA771	2	80 W	7 35858 19887 5

MULTI-CORE INTEL® XEON® PROCESSOR 5000 SEQUENCE *continued*

PROCESSOR NAME	PRODUCT CODE	CLOCK SPEED	FRONT SIDE BUS	CACHE	PACKAGE	# OF CPUS SUPPORTED	POWER	UPC CODE
Intel® Xeon® Processor Processor L5430	<b>BX80574L5430P</b> <i>(2U passive heatsink)</i>	2.66 GHz	1333 MHz	12 MB	LGA771	2	50 W	7 35858 20376 0
	<b>BX80574L5430A</b> <i>(active or 1U heatsink)</i>	2.66 GHz	1333 MHz	12 MB	LGA771	2	50 W	7 35858 20375 3
Intel Xeon Processor E5420	<b>BX80574E5420P</b> <i>(2U passive heatsink)</i>	2.50 GHz	1333 MHz	12 MB	LGA771	2	80 W	7 35858 19890 5
	<b>BX80574E5420A</b> <i>(active or 1U heatsink)</i>	2.50 GHz	1333 MHz	12 MB	LGA771	2	80 W	7 35858 19889 9
Intel Xeon Processor L5420	<b>BX80574L5420P</b> <i>(2U passive heatsink)</i>	2.50 GHz	1333 MHz	12 MB	LGA771	2	50 W	7 35858 19896 7
	<b>BX80574L5420A</b> <i>(active or 1U heatsink)</i>	2.50 GHz	1333 MHz	12 MB	LGA771	2	50 W	7 35858 19895 0
Intel Xeon Processor E5410	<b>BX80574E5410P</b> <i>(2U passive heatsink)</i>	2.33 GHz	1333 MHz	12 MB	LGA771	2	80 W	7 35858 19892 9
	<b>BX80574E5410A</b> <i>(active or 1U heatsink)</i>	2.33 GHz	1333 MHz	12 MB	LGA771	2	80 W	7 35858 19891 2
Intel Xeon Processor L5410	<b>BX80574L5410P</b> <i>(2U passive heatsink)</i>	2.33 GHz	1333 MHz	12 MB	LGA771	2	50 W	7 35858 19898 1
	<b>BX80574L5410A</b> <i>(active or 1U heatsink)</i>	2.33 GHz	1333 MHz	12 MB	LGA771	2	50 W	7 35858 19897 4
Intel Xeon Processor E5405	<b>BX80574E5405P</b> <i>(2U passive heatsink)</i>	2 GHz	1333 MHz	12 MB	LGA771	2	80 W	7 35858 19894 3
	<b>BX80574E5405A</b> <i>(active or 1U heatsink)</i>	2 GHz	1333 MHz	12 MB	LGA771	2	80 W	7 35858 19893 6
Intel Xeon Processor X5365	<b>BX80563X5365P</b> <i>(2U passive heatsink)</i>	3 GHz	1333 MHz	8 MB	LGA771	2	120 W	7 35858 19544 7
	<b>BX80563X5365A</b> <i>(active or 1U heatsink)</i>	3 GHz	1333 MHz	8 MB	LGA771	2	120 W	7 35858 19543 0
Intel Xeon Processor X5355	<b>BX80563X5355P</b> <i>(2U passive heatsink)</i>	2.66 GHz	1333 MHz	8 MB	LGA771	2	120 W	7 35858 19140 1
	<b>BX80563X5355A</b> <i>(active or 1U heatsink)</i>	2.66 GHz	1333 MHz	8 MB	LGA771	2	120 W	7 35858 19139 5
Intel Xeon Processor E5345	<b>BX80563E5345P</b> <i>(2U passive heatsink)</i>	2.33 GHz	1333 MHz	8 MB	LGA771	2	80 W	7 35858 19142 5
	<b>BX80563E5345A</b> <i>(active or 1U heatsink)</i>	2.33 GHz	1333 MHz	8 MB	LGA771	2	80 W	7 35858 19141 8

MULTI-CORE INTEL® XEON® PROCESSOR 5000 SEQUENCE *continued*

PROCESSOR NAME	PRODUCT CODE	CLOCK SPEED	FRONT SIDE BUS	CACHE	PACKAGE	# OF CPUS SUPPORTED	POWER	UPC CODE
Intel® Xeon® Processor E5335	BX80563E5335P <i>(2U passive heatsink)</i>	2 GHz	1333 MHz	8 MB	LGA771	2	80 W	7 35858 19144 9
	BX80563E5335A <i>(active or 1U heatsink)</i>	2 GHz	1333 MHz	8 MB	LGA771	2	80 W	7 35858 19143 2
Intel Xeon Processor L5335	BX80563L5335P <i>(2U passive heatsink)</i>	2 GHz	1333 MHz	8 MB	LGA771	2	50 W	7 35858 19545 4
	BX80563L5335A <i>(active or 1U heatsink)</i>	2 GHz	1333 MHz	8 MB	LGA771	2	50 W	7 35858 19546 1
Intel Xeon Processor E5320	BX80563E5320P <i>(2U passive heatsink)</i>	1.86 GHz	1066 MHz	8 MB	LGA771	2	80 W	7 35858 19040 4
	BX80563E5320A <i>(active or 1U heatsink)</i>	1.86 GHz	1066 MHz	8 MB	LGA771	2	80 W	7 35858 19039 8
Intel Xeon Processor L5320	BX80563L5320P <i>(2U passive heatsink)</i>	1.86 GHz	1066 MHz	8 MB	LGA771	2	50 W	7 35858 19255 2
	BX80563L5320A <i>(active or 1U heatsink)</i>	1.86 GHz	1066 MHz	8 MB	LGA771	2	50 W	7 35858 19254 5
Intel Xeon Processor E5310	BX80563E5310P <i>(2U passive heatsink)</i>	1.60 GHz	1066 MHz	8 MB	LGA771	2	80 W	7 35858 19081 7
	BX80563E5310A <i>(active or 1U heatsink)</i>	1.60 GHz	1066 MHz	8 MB	LGA771	2	80 W	7 35858 19080 0
Intel Xeon Processor X5272	EU80573KL0966M <i>(tray only)</i>	3.40 GHz	1600 MHz	6 MB	LGA771	2	80 W	
Intel Xeon Processor X5260	EU80573KJ0936M <i>(tray only)</i>	3.33 GHz	1333 MHz	6 MB	LGA771	2	80 W	
Intel Xeon Processor L5240	EU80573JJ0806M <i>(tray only)</i>	3 GHz	1333 MHz	6 MB	LGA771	2	40 W	
Intel Xeon Processor E5205	BX80573E5205P <i>(2U passive heatsink)</i>	1.86 GHz	1066 MHz	6 MB	LGA771	2	65 W	7 35858 19911 7
	BX80573E5205A <i>(active or 1U heatsink)</i>	1.86 GHz	1066 MHz	6 MB	LGA771	2	65 W	7 35858 19910 0
Intel Xeon Processor 5160	BX805565160P <i>(2U passive heatsink)</i>	3 GHz	1333 MHz	4 MB	LGA771	2	65 W	7 35858 18426 7
	BX805565160A <i>(active or 1U heatsink)</i>	3 GHz	1333 MHz	4 MB	LGA771	2	65 W	7 35858 18425 0

MULTI-CORE INTEL® XEON® PROCESSOR 5000 SEQUENCE *continued*

PROCESSOR NAME	PRODUCT CODE	CLOCK SPEED	FRONT SIDE BUS	CACHE	PACKAGE	# OF CPUS SUPPORTED	POWER	UPC CODE
Intel® Xeon® Processor Processor 5150	<b>BX805565150P</b> <i>(2U passive heatsink)</i>	2.66 GHz	1333 MHz	4 MB	LGA771	2	65 W	7 35858 18428 1
	<b>BX805565150A</b> <i>(active or 1U heatsink)</i>	2.66 GHz	1333 MHz	4 MB	LGA771	2	65 W	7 35858 18427 4
Intel Xeon Processor LV 5148	<b>BX805565148P</b> <i>(2U passive heatsink)</i>	2.33 GHz	1333 MHz	4 MB	LGA771	2	40 W	7 35858 18438 0
	<b>BX805565148A</b> <i>(active or 1U heatsink)</i>	2.33 GHz	1333 MHz	4 MB	LGA771	2	40 W	7 35858 18437 3
Intel Xeon Processor 5140	<b>BX805565140P</b> <i>(2U passive heatsink)</i>	2.33 GHz	1333 MHz	4 MB	LGA771	2	65 W	7 35858 18430 4
	<b>BX805565140A</b> <i>(active or 1U heatsink)</i>	2.33 GHz	1333 MHz	4 MB	LGA771	2	65 W	7 35858 18429 8
Intel Xeon Processor 5130	<b>BX805565130P</b> <i>(2U passive heatsink)</i>	2 GHz	1333 MHz	4 MB	LGA771	2	65 W	7 35858 18432 8
	<b>BX805565130A</b> <i>(active or 1U heatsink)</i>	2 GHz	1333 MHz	4 MB	LGA771	2	65 W	7 35858 18431 1
Intel Xeon Processor 5120	<b>BX805565120P</b> <i>(2U passive heatsink)</i>	1.86 GHz	1066 MHz	4 MB	LGA771	2	65 W	7 35858 18434 2
	<b>BX805565120A</b> <i>(active or 1U heatsink)</i>	1.86 GHz	1066 MHz	4 MB	LGA771	2	65 W	7 35858 18433 5
Intel Xeon Processor 5110	<b>BX805565110P</b> <i>(2U passive heatsink)</i>	1.60 GHz	1066 MHz	4 MB	LGA771	2	65 W	7 35858 18436 6
	<b>BX805565110A</b> <i>(active or 1U heatsink)</i>	1.60 GHz	1066 MHz	4 MB	LGA771	2	65 W	7 35858 18435 9

MULTI-CORE INTEL® XEON® PROCESSOR 7000 SEQUENCE

PROCESSOR NAME	PRODUCT CODE	CLOCK SPEED	FRONT SIDE BUS	CACHE	PACKAGE	# OF CPUS SUPPORTED	POWER	UPC CODE
Intel® Xeon® Processor X7460	BX80582X7460	2.67 GHz	1066 MHz	16 MB L3	mPGA 604-pin	4	130 W	7 35858 20355 5
Intel Xeon Processor L7455	AD80582JH046003 <i>(tray only)</i>	2.13 GHz	1066 MHz	12 MB L3	mPGA 604-pin	4	50 W	
Intel Xeon Processor E7450	BX80582E7450	2.40 GHz	1066 MHz	12 MB L3	mPGA 604-pin	4	90 W	7 35858 20356 2
Intel Xeon Processor L7445	AD80583JH046003 <i>(tray only)</i>	2.13 GHz	1066 MHz	12 MB L3	mPGA 604-pin	4	50 W	
Intel Xeon Processor E7440	BX80583E7440	2.40 GHz	1066 MHz	16 MB L3	mPGA 604-pin	4	90 W	7 35858 20357 9
Intel Xeon Processor E7430	AD80583QH046003 <i>(tray only)</i>	2.13 GHz	1066 MHz	12 MB L3	mPGA 604-pin	4	90 W	
Intel Xeon Processor E7420	BX80583E7420	2.13 GHz	1066 MHz	8 MB L3	mPGA 604-pin	4	90 W	7 35858 20358 6
Intel Xeon Processor X7350	BX80565X7350	2.93 GHz	1066 MHz	8 MB	mPGA 604-pin	4	130 W	7 35858 19665 9
Intel Xeon Processor E7340	BX80565E7340	2.40 GHz	1066 MHz	8 MB	mPGA 604-pin	4	80 W	7 35858 19666 6
Intel Xeon Processor E7330	BX80565E7330	2.40 GHz	1066 MHz	6 MB	mPGA 604-pin	4	80 W	7 35858 19667 3
Intel Xeon Processor E7320	BX80565E7320	2.13 GHz	1066 MHz	4 MB	mPGA 604-pin	4	80 W	7 35858 19668 0
Intel Xeon Processor E7310	BX80565E7310	1.60 GHz	1066 MHz	4 MB	mPGA 604-pin	4	80 W	7 35858 19669 7
Intel Xeon Processor L7345	LF80565JH0368M <i>(tray only)</i>	1.86 GHz	1066 MHz	8 MB	mPGA 604-pin	4	50 W	
Intel Xeon Processor 7220	LF80564QH0778M <i>(tray only)</i>	2.93 GHz	1066 MHz	8 MB	mPGA 604-pin	4	80 W	
Intel Xeon Processor 7210	LF80564QH0568M <i>(tray only)</i>	2.40 GHz	1066 MHz	8 MB	mPGA 604-pin	4	80 W	

All products and dates specified are preliminary based on current expectations and are subject to change without notice. Availability in different channels may vary.

Intel, the Intel logo, Xeon, and Xeon Inside are trademarks of Intel Corporation in the U.S. and other countries.

\*Other names and brands may be claimed as the property of others.

Copyright © 2008 Intel Corporation. All rights reserved. 1008/RR/MS Part Number: 252625-024US October 2008

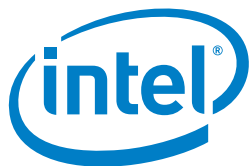

## INTEL® SERVER BOARDS



**Intel® Server Board  
S5400SF**

Dual-processor server board with large memory footprint for high-performance and high-density computing



**Intel® Server Board  
S5000PSL (ROMB)**

High-performance server board for maximum reliability and manageability



**Intel® Server Board  
S5000PSL (SAS)**

High-performance server board for maximum reliability and manageability

Boards	Intel® Server Board S5400SF	Intel® Server Board S5000PSL (ROMB)	Intel® Server Board S5000PSL (SAS)
<b>Order Code</b>	<b>S5400SF</b>	<b>S5000PSLROMBR<sup>3</sup></b>	<b>S5000PSLSASR<sup>3</sup></b>
<b>Intel® Server Chassis Support</b>	Intel® Server System SR1560SF ( <i>integrated system</i> ) Intel® Server System SR1560SFHS ( <i>integrated system</i> )	Intel® Server Chassis SC5400 LX Intel® Server Chassis SC5400 BRP Intel® Server Chassis SC5400 Base Intel® Entry Server Chassis SC5299BRP Intel® Entry Server Chassis SC5299DP	Intel® Server Chassis SC5400 LX Intel® Server Chassis SC5400 BRP Intel® Server Chassis SC5400 Base Intel® Entry Server Chassis SC5299BRP Intel® Entry Server Chassis SC5299DP
<b>Processor Support<sup>1</sup></b>	<b>Multi-Core Intel® Xeon® processor</b>	<b>Multi-Core Intel® Xeon® processor</b>	<b>Multi-Core Intel® Xeon® processor</b>
<b>Number of Processors Supported</b>	2	2	2
<b>System Bus Speed</b>	1600 MHz <sup>2</sup> / 1333 MHz / 1066 MHz	1333 MHz <sup>4</sup> / 1066 MHz / 667 MHz	1333 MHz <sup>4</sup> / 1066 MHz / 667 MHz
<b>Chipset</b>	Intel® 5400 Chipset	Intel® 5000P Server Chipset	Intel® 5000P Server Chipset
<b>Independent PCI Buses</b>	4	6	7
<b>Total Slots</b>	1	6	6
<b>Slot Types</b>	1 x PCI Express* 2.0 x16 ( <i>2nd Gen PCIe</i> ) Optional Intel® I/O Expansion Module ( <i>Ext 4-port SAS; Dual GigE; IB</i> )	3 x PCI Express* x8 1 x PCI Express x4 ( <i>x8 Connector</i> ) 2 x PCI-X 64-bit 100/133 MHz	2 x PCI Express* x8 2 x PCI Express x4 ( <i>x8 Connectors</i> ) 2 x PCI-X 64-bit 100/133 MHz
<b>Memory Capacity</b>	64 GB ECC Fully Buffered DDR2 ( <i>16 DIMMs</i> )	32 GB ECC FBDIMMs ( <i>8 DIMMs</i> )	32 GB ECC FBDIMMs ( <i>8 DIMMs</i> )
<b>Integrated SCSI</b>	Not available	Not available	Not available
<b>Integrated ATA</b>	1-port for optical drive support	1 channel supporting up to 2 IDE devices	1 channel supporting up to 2 IDE devices
<b>Integrated Serial ATA</b>	6-port SATA ( <i>3.0 Gb/s</i> ) and RAID 0, 1, 10, and optional RAID 5	Enhanced support for 6-ports at 3.0 Gb/s with RAID 0, 1, 10, and optional AXXRAKSw5 for RAID 5	2-port SATA ( <i>3.0 Gb/s</i> ) with RAID 0, 1, and 10
<b>Integrated Active SAS Controller</b>	Not available on board. Option is available for hot swap integrated system	8-port SAS via included ROMB card ( <i>Supports optional upgrade to hardware RAID 0, 1, 5, 10, 50</i> )	4-port SAS with Intel® Embedded RAID Technology II providing RAID 0, 1, 10, and optional AXXRAKSw5 for RAID 5
<b>Integrated LAN</b>	2 x Intel® Gigabit Ethernet Controller	2 x Intel® Gigabit Ethernet Controller	2 x Intel® Gigabit Ethernet Controller
<b>Integrated Graphics</b>	ATI* with 32 MB memory	ATI* with 16 MB memory	ATI* with 16 MB memory
<b>Server Management Support</b>	Intel® Server Essentials 2.0 Intelligent Platform Management Interface 2.0 Support for Intel® Remote Management Module ( <i>AXXRM2</i> )	Intel® Server Essentials 2.0 Intelligent Platform Management Interface 2.0 Support for Intel® Remote Management Module ( <i>AXXRM2</i> )	Intel® Server Essentials 2.0 Intelligent Platform Management Interface 2.0 Support for Intel® Remote Management Module ( <i>AXXRM2</i> )
<b>Intel® RAID Support</b>	Includes Intel® Embedded RAID Technology and compatible with Intel® RAID Controllers	Includes Intel® Embedded RAID Technology and upgradeable to full-featured integrated RAID, and compatible with Intel® RAID Controllers	Includes Intel® Embedded RAID Technology and compatible with Intel® RAID Controllers

For more information, visit the Intel Web site at: [www.intel.com/go/serverboards](http://www.intel.com/go/serverboards)



Boards	Intel® Server Board S5000PSL (SATA)	Intel® Workstation Board S5000XVN (SAS)	Intel® Workstation Board S5000XVN (SATA)
	<i>High-performance server board for maximum reliability and manageability</i>	<i>High-performance dual processor workstation board</i>	<i>High-performance dual processor workstation board</i>
<b>Order Code</b>	<b>S5000PSLSATAR<sup>3</sup></b>	<b>S5000XVNSASR<sup>3</sup></b>	<b>S5000XVNSATAR<sup>3</sup></b>
<b>Intel® Server Chassis Support</b>	Intel® Server Chassis SC5400 LX Intel® Server Chassis SC5400 BRP Intel® Server Chassis SC5400 Base Intel® Entry Server Chassis SC5299BRP Intel® Entry Server Chassis SC5299DP	Intel® Server Chassis SC5400 Base Intel® Entry Server Chassis SC5299WS	Intel® Server Chassis SC5400 Base Intel® Entry Server Chassis SC5299WS
<b>Processor Support<sup>1</sup></b>	<b>Multi-Core Intel® Xeon® processor</b>	<b>Multi-Core Intel® Xeon® processor</b>	<b>Multi-Core Intel® Xeon® processor</b>
<b>Number of Processors Supported</b>	2	2	2
<b>System Bus Speed</b>	1333 MHz <sup>4</sup> / 1066 MHz / 667 MHz	1333 MHz <sup>4</sup> / 1066 MHz / 667 MHz	1333 MHz <sup>4</sup> / 1066 MHz / 667 MHz
<b>Chipset</b>	Intel® 5000P Server Chipset	Intel® 5000X Server Chipset	Intel® 5000X Server Chipset
<b>Independent PCI Buses</b>	6	6	5
<b>Total Slots</b>	6	5	5
<b>Slot Types</b>	3 x PCI Express* x8 1 x PCI Express x4 (x8 Connector) 2 x PCI-X 64-bit 100/133 MHz	1 x PCI Express* x16 2 x PCI Express x4 (x8 Connectors) 2 x PCI-X 64-bit 100/133 MHz	1 x PCI Express* x16 1 x PCI Express x8 1 x PCI Express x4 (x8 Connector) 2 x PCI-X 64-bit 100/133 MHz
<b>Memory Capacity</b>	32 GB ECC FBDIMMs (8 DIMMs)	32 GB ECC FBDIMMs (8 DIMMs)	32 GB ECC FBDIMMs (8 DIMMs)
<b>Integrated SCSI</b>	Not available	Not available	Not available
<b>Integrated ATA</b>	1 channel supporting up to 2 IDE devices	1 channel supporting up to 2 IDE devices	1 channel supporting up to 2 IDE devices
<b>Integrated Serial ATA</b>	Enhanced SATA provides 6-ports and RAID 0, 1, 10, and optional AXXRAKSW5 for RAID 5	2-port SATA (3.0 Gb/s) with RAID 0, 1, and 10	6-port SATA (3.0 Gb/s) with RAID 0, 1, 10, and optional AXXRAKSW5 for RAID 5
<b>Integrated Active SAS Controller</b>	Not available	4-port SAS with Intel® Embedded RAID Technology II providing RAID 0, 1, 10, and optional AXXRAKSW5 for RAID 5	Not available
<b>Integrated LAN</b>	2 x Intel® Gigabit Ethernet Controller	2 x Intel® Gigabit Ethernet Controller	2 x Intel® Gigabit Ethernet Controller
<b>Integrated Graphics</b>	ATI* with 16 MB memory	Not available	Not available
<b>Server Management Support</b>	Intel® Server Essentials 2.0 Intelligent Platform Management Interface 2.0 Support for Intel® Remote Management Module (AXXRM2)	Intel® Server Essentials 2.0 Intelligent Platform Management Interface 2.0	Intel® Server Essentials 2.0 Intelligent Platform Management Interface 2.0
<b>Intel® RAID Support</b>	Includes Intel® Embedded RAID Technology and compatible with Intel® RAID Controllers	Includes Intel® Embedded RAID Technology and upgradable to full-featured integrated RAID, and compatible with Intel® RAID Controllers	Includes Intel® Embedded RAID Technology and compatible with Intel® RAID Controllers



Boards	Intel® Server Board S5000VSA (SATA)	Intel® Server Board S5000VSA (SCSI)	Intel® Server Board S5000VSA (4 DIMM)	Intel® Server Board S5000VSA (SAS)
	<i>Entry server board for small and medium businesses</i>	<i>Entry server board for small and medium businesses</i>	<i>Entry server board for small and medium businesses</i>	<i>Entry server board for small and medium businesses</i>
Order Code	<b>S5000VSASATAR<sup>3</sup></b>	<b>S5000VSASC SIR<sup>3</sup></b>	<b>S5000VSA4DIMMR<sup>3</sup></b>	<b>S5000VSASASR<sup>3</sup></b>
Intel® Server Chassis Support	Intel® Entry Server Chassis SC5299DP Intel® Entry Server Chassis SC5299BRP Intel® Entry Server System SR2520SAX	Intel® Entry Server Chassis SC5299DP Intel® Entry Server Chassis SC5299BRP	Intel® Entry Server Chassis SC5299DP Intel® Entry Server System SR2520SAF	Intel® Entry Server Chassis SC5299DP Intel® Entry Server Chassis SC5299BRP Intel® Entry Server System SR2520SAXS
Processor Support <sup>1</sup>	<b>Multi-Core Intel® Xeon® processor</b>	<b>Multi-Core Intel® Xeon® processor</b>	<b>Multi-Core Intel® Xeon® processor</b>	<b>Multi-Core Intel® Xeon® processor</b>
Number of Processors Supported	2	2	2	2
System Bus Speed	1333 MHz <sup>4</sup> / 1066 MHz / 667 MHz	1333 MHz <sup>4</sup> / 1066 MHz / 667 MHz	1333 MHz <sup>4</sup> / 1066 MHz / 667 MHz	1333 MHz <sup>4</sup> / 1066 MHz / 667 MHz
Chipset	Intel® 5000V Server Chipset	Intel® 5000V Server Chipset	Intel® 5000V Server Chipset	Intel® 5000V Server Chipset
Independent PCI Buses	4	4	4	4
Total Slots	5	5	5	5
Slot Types	2 x PCI Express* x4 (x8 Connectors) 2 x PCI-X 64 MHz/133 MHz 1 x PCI 32-bit/33 MHz	2 x PCI Express* x4 (x8 Connectors) 2 x PCI-X 64 MHz/133 MHz 1 x PCI 32-bit/33 MHz	2 x PCI Express* x4 (x8 Connectors) 2 x PCI-X 64 MHz/133 MHz 1 x PCI 32-bit/33 MHz	2 x PCI Express* x4 (x8 Connectors) 2 x PCI-X 64 MHz/133 MHz 1 x PCI 32-bit/33 MHz
Memory Capacity	16 GB ECC FBDIMMs (8 DIMMs)	16 GB ECC FBDIMMs (8 DIMMs)	8 GB ECC FBDIMMs (4 DIMMs)	16 GB ECC FBDIMMs (8 DIMMs)
Integrated SCSI	Not available	Single Channel SCSI Add-in Card at 133 MHz	Not available	Not available
Integrated ATA	1 channel supporting up to 2 IDE devices	1 channel supporting up to 2 IDE devices	1 channel supporting up to 2 IDE devices	1 channel supporting up to 2 IDE devices
Integrated Serial ATA	Enhanced SATA provides 6-ports and RAID 0, 1, 10, and optional AXXRAKSW5 for RAID 5	Enhanced SATA provides 6-ports and RAID 0, 1, 10, and optional AXXRAKSW5 for RAID 5	6 channels (3.0 Gb/s) with support for RAID 0, 1, and 10	2-port SATA (3.0 Gb/s) with RAID 0, 1, and 10
Integrated Active SAS Controller	Not available	Not available	Not available	4-port SAS with Intel® Embedded Server RAID Technology II providing RAID 0, 1, 10, and optional AXXRAKSW5 for RAID 5
Integrated LAN	2 x Intel® Gigabit Ethernet Controller	2 x Intel® Gigabit Ethernet Controller	2 x Intel® Gigabit Ethernet Controller	2 x Intel® Gigabit Ethernet Controller
Integrated Graphics	ATI* with 16 MB memory	ATI* with 16 MB memory	ATI* with 16 MB memory	ATI* with 16 MB memory
Server Management Support	Intel® Server Essentials 2.0 Intelligent Platform Management Interface 2.0	Intel® Server Essentials 2.0 Intelligent Platform Management Interface 2.0	Intel® Server Essentials 2.0 Intelligent Platform Management Interface 2.0	Intel® Server Essentials 2.0 Intelligent Platform Management Interface 2.0
Intel® RAID Support	Includes Intel® Embedded RAID Technology and compatible with Intel® RAID Controllers	Includes Intel® Embedded RAID Technology and upgradable to full-featured integrated RAID, and compatible with Intel® RAID Controllers	Includes Intel® Embedded RAID Technology and compatible with Intel® RAID Controllers	Includes Intel® Embedded RAID Technology and upgradable to full-featured integrated RAID, and compatible with Intel® RAID Controllers



Boards	Intel® Server Board S5000PAL	Intel® Entry Server Board S3000AHLX	Intel® Entry Server Board S3000AH
	<i>Outstanding performance, dependability, and manageability for high-density solutions</i>	<i>Entry server board with essential server-class features</i>	<i>Entry server board with essential server-class features</i>
Order Code	<b>S5000PALR<sup>2</sup></b>	<b>S3000AHLX</b>	<b>S3000AHLX</b>
Intel® Server Chassis Support	Intel® Server Chassis SR1500 (1U) Intel® Server Chassis SR1550 (1U Redundant) Intel® Server Chassis SR2500 (2U) Integrated systems also available	Intel® Server Chassis SC5295UP Intel® Server System SR1530AHLX Intel® Server System SR1530HAHLX	Intel® Server Chassis SC5295UP Intel® Server System SR1530AH
Processor Support <sup>1</sup>	<b>Multi-Core Intel® Xeon® processor</b>	<b>Intel® Xeon® 3200 series, Intel® Pentium® D, Intel® Pentium® Extreme Edition, Intel® Pentium® 4, and Intel® Celeron® D processors</b>	<b>Intel® Xeon® 3200 series, Intel® Pentium® D, Intel® Pentium® Extreme Edition, Intel® Pentium® 4, and Intel® Celeron® D processors</b>
Number of Processors Supported	2	1	1
System Bus Speed	1333 MHz <sup>4</sup> / 800 MHz / 667 MHz	1066 MHz / 800 MHz / 533 MHz	1066 MHz / 800 MHz / 533 MHz
Chipset	Intel® 5000P Chipset	Intel® 3000 Server Chipset	Intel® 3000 Server Chipset
Independent PCI Buses	4	6	5
Total Slots	5 (2U) 2 (1U)	5	5
Slot Types	PCI adapter cards are supported in the PCI-X and PCI-Express* formats and accessed through two riser slots: 1U Chassis: Up to two adapter card slots 2U Chassis: Up to five adapter card slots plus Intel® I/O Expansion Module.	1 x PCI Express* x1 1 x PCI-X 64-bit/133 MHz 2 x PCI 32-bit/33 MHz 1 x Intel® Adaptive Slot supporting PCI Express x8 or PCI-X 64-bit/133 MHz	1 x PCI Express* x8 1 x PCI Express x4 1 x PCI Express x1 2 x PCI 32-bit/33 MHz
Memory Capacity	32 GB ECC Fully Buffered DDR2 (8 DIMMs)	Dual memory-channel, four DIMM slots for DDR2 533/667 Unbuffered ECC/non-ECC DIMMs (8 GB Max)	Dual memory-channel, four DIMM slots for DDR2 533/667 Unbuffered ECC/non-ECC DIMMs (8 GB Max)
Integrated SCSI	Not available	Not available	Not available
Integrated ATA	1 channel supporting 1 IDE-100 Optical Drive	1 channel supporting up to 2 IDE devices	1 channel supporting up to 2 IDE devices
Integrated Serial ATA	Enhanced SATA provides 6-ports and RAID 0, 1, 10, and optional AXXRAKSW5 for RAID 5	4-port SATA (3.0 Gb/s)	4-port SATA (3.0 Gb/s)
Integrated LAN	2 x Intel® Gigabit Ethernet Controller	2 x Intel® Gigabit Ethernet Controller	2 x Intel® Gigabit Ethernet Controller
Integrated Graphics	ATI* with 16 MB memory	ATI* with 16 MB memory	ATI* with 16 MB memory
Server Management Support	Intel® Server Essentials 2.0 Intelligent Platform Management Interface 2.0 Support for Intel® Remote Management Module (AXXRMM2)	Intel® Server Essentials 2.0	Intel® Server Essentials 2.0
Intel® RAID Support	Includes Intel® Embedded RAID Technology and upgradable to full-featured integrated RAID, and compatible with Intel® RAID Controllers	Includes Intel® Embedded RAID Technology and compatible with Intel® RAID Controllers	Includes Intel® Embedded RAID Technology and compatible with Intel® RAID Controllers



Boards	Intel® Entry Server Board S3000AHV	Intel® Server Board X38ML	Intel® Entry Server Board S3210SHLX
	<i>Entry server board with essential server-class features</i>	<i>Small form factor server board for high-performance and high-density computing</i>	<i>Entry server board with essential server-class features</i>
<b>Order Code</b>	<b>S3000AHV</b>	<b>X38ML</b>	<b>S3210SHLX</b>
<b>Intel® Server Chassis and Platform Support</b>	Intel® Server Chassis SC5295UP	Intel® Server System SR1520ML	Intel® Server Chassis SC5299UP
<b>Processor Support<sup>1</sup></b>	Intel® Xeon® 3200 series, Intel® Pentium® D, Intel® Pentium® 4, and Intel® Celeron® D processors	Intel® Xeon® 3200 and 3000 series, Intel® Core™2 Quad, Intel® Core™2 Duo, Intel® Core™2 Extreme Quad-Core, Intel® Core™2 Extreme Dual-Core, Quad-Core Intel® Xeon® 3300 series, and Dual-Core Intel® Xeon® 3100 series processors	Intel® Xeon® 3200 and 3000 series, Intel® Pentium® D, Intel® Pentium® Extreme Edition, Intel® Pentium® 4, Quad-Core Intel® Xeon® 3300 series, and Dual-Core Intel® Xeon® 3100 series processors
<b>Number of Processors Supported</b>	1	1	1
<b>System Bus Speed</b>	1066 MHz / 800 MHz / 533 MHz	1333 MHz <sup>4</sup> / 1066 MHz / 800 MHz	1333 MHz <sup>4</sup> / 1066 MHz / 800 MHz
<b>Chipset</b>	Intel® 3000 Server Chipset	Intel® X38 Express Chipset	Intel® 3210 Server Chipset
<b>Independent PCI Buses</b>	4	1	6
<b>Total Slots</b>	4	1	5
<b>Slot Types</b>	1 x PCI Express* x8 1 x PCI Express x4 2 x PCI 32-bit/33 MHz	1 x PCI Express* 2.0 x16 (2nd Gen PCIe)	1 x PCI Express* x16 w/x16 connector 1 x PCI Express x8 w/x8 connector 2 x PCI-X 64/133MHz 1 x PCI 32/33 (5V)
<b>Memory Capacity</b>	Dual memory-channel, four DIMM slots for DDR2 533/667 Unbuffered ECC/non-ECC DIMMs (8 GB Max)	Dual memory-channel, four DIMM slots for DDR2 667/800 Unbuffered ECC/non-ECC DIMMs (8 GB Max)	Dual memory-channel, four DIMM slots for DDR2 667/800 Unbuffered ECC/non-ECC DIMMs (8 GB Max)
<b>Integrated SCSI</b>	Not available	Not available	Not available
<b>Integrated ATA</b>	1 channel supporting up to 2 IDE devices	Not available	Not available
<b>Integrated Serial ATA</b>	4-port SATA (3.0 Gb/s)	4-port SATA (3.0 Gb/s)	6-port SATA (3.0 Gb/s)
<b>Integrated LAN</b>	1 x Intel® Gigabit Ethernet Controller	2 x Intel® Gigabit Ethernet Controller	2 x Intel® Gigabit Ethernet Controller
<b>Integrated Graphics</b>	ATI* with 16 MB memory	ServerEngines* iBMC	ServerEngines* iBMC with 8 MB memory
<b>Server Management Support</b>	Intel® Server Essentials 2.0 Intelligent Platform Management Interface 2.0	Intel® Server Essentials 2.0 Intelligent Platform Management Interface 2.0	Intel® Server Essentials 2.0 Intelligent Platform Management Interface 2.0
<b>Intel® RAID Support</b>	Includes Intel® Embedded RAID Technology and compatible with Intel® RAID Controllers	Includes Intel® Embedded RAID Technology and compatible with Intel® RAID Controllers	Includes Intel® Embedded RAID Technology and compatible with Intel® RAID Controllers



Boards	Intel® Entry Server Board S3210SHLC	Intel® Entry Server Board S3200SHV
	<i>Essential server features for entry-level applications</i>	<i>Essential server features for entry-level applications</i>
Order Code	<b>S3210SHLC</b>	<b>S3200SHV</b>
Intel® Server Chassis and Platform Support	Intel® Server Chassis SC5299UP	Intel® Server Chassis SC5299UP
Processor Support <sup>1</sup>	<b>Intel® Xeon® 3200 and 3000 series, Intel® Pentium® D, Intel® Pentium® Extreme Edition, Intel® Pentium® 4, Quad-Core Intel® Xeon® 3300 series, and Dual-Core Intel® Xeon® 3100 series processors</b>	<b>Intel® Xeon® 3200 and 3000 series, Intel® Pentium® D, Intel® Pentium® Extreme Edition, Intel® Pentium® 4, Quad-Core Intel® Xeon® 3300 Series, and Dual-Core Intel® Xeon® 3100 series processors</b>
Number of Processors Supported	1	1
System Bus Speed	1333 MHz <sup>4</sup> / 1066 MHz / 800 MHz	1333 MHz <sup>4</sup> / 1066 MHz / 800 MHz
Chipset	Intel® 3210 Server Chipset	Intel® 3200 Chipset
Independent PCI Buses	5	4
Total Slots	5	4
Slot Types	1 x PCI Express* x16 w/x16 connector 1 x PCI Express x8 w/x8 connector 1 x PCI Express x4 2 x PCI 32-bit/33 MHz	1 x PCI Express* x8 1 x PCI Express x4 2 x PCI 32-bit/33 MHz
Memory Capacity	Dual memory-channel, four DIMM slots for DDR2 667/800 Unbuffered ECC/non-ECC DIMMs (8 GB Max)	Dual memory-channel, four DIMM slots for DDR2 667/800 Unbuffered ECC/non-ECC DIMMs (8 GB Max)
Integrated SCSI	Not available	Not available
Integrated ATA	Not available	Not available
Integrated Serial ATA	6-port SATA (3.0 Gb/s)	6-port SATA (3.0 Gb/s)
Integrated LAN	2 x Intel® Gigabit Ethernet Controller	1 x Intel® Gigabit Ethernet Controller
Integrated Graphics	ServerEngines* iBMC with 8 MB memory	ServerEngines* iBMC with 8 MB memory
Server Management Support	Intel® Server Essentials 2.0 Intelligent Platform Management Interface 2.0	Intel® Server Essentials 2.0 Intelligent Platform Management Interface 2.0
Intel® RAID Support	Includes Intel® Embedded RAID Technology and compatible with Intel® RAID Controllers	Includes Intel® Embedded RAID Technology and compatible with Intel® RAID Controllers

<sup>1</sup> Refer to <http://support.intel.com/support/motherboards/server> for up-to-date details on processors supported by each server board.

<sup>2</sup> 1600 MHz support may require updates that may not be available at launch.

<sup>3</sup> Order codes ending in "R" designate refreshed products that now support the new generation of 45nm processors. Please see the supported processor page for each product on [support.intel.com](http://support.intel.com) for a full list of supported processors.

<sup>4</sup> 1333 MHz support may require updates that may not be available at launch.

<sup>5</sup> May require latest board revision, visit [www.intel.com/products/desktop/motherboard/index.htm](http://www.intel.com/products/desktop/motherboard/index.htm) for more information.

All products and dates specified are preliminary based on current expectations and are subject to change without notice. Availability in different channels may vary.

Intel, the Intel logo, Intel Core, Pentium, Xeon, and Celeron are trademarks of Intel Corporation in the U.S. and other countries.

\*Other names and brands may be claimed as the property of others.

Copyright © 2008 Intel Corporation. All rights reserved. 1008/RR/MS Part Number: 252626-024US **October 2008**

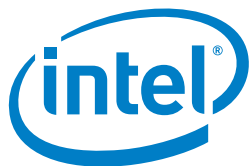

# Intel® Server Essentials

## Making IT easy for small and midsize businesses

Small and midsize businesses (SMBs) face complex IT challenges similar to those of large enterprises, but often without the large budget or staff of IT specialists.

Intel® Server Essentials offers software and hardware solutions that:

- Make it easy to set up and maintain a reliable and secure IT infrastructure
- Reduce the cost and time of managing servers, desktops, and applications
- Keep businesses running 24/7

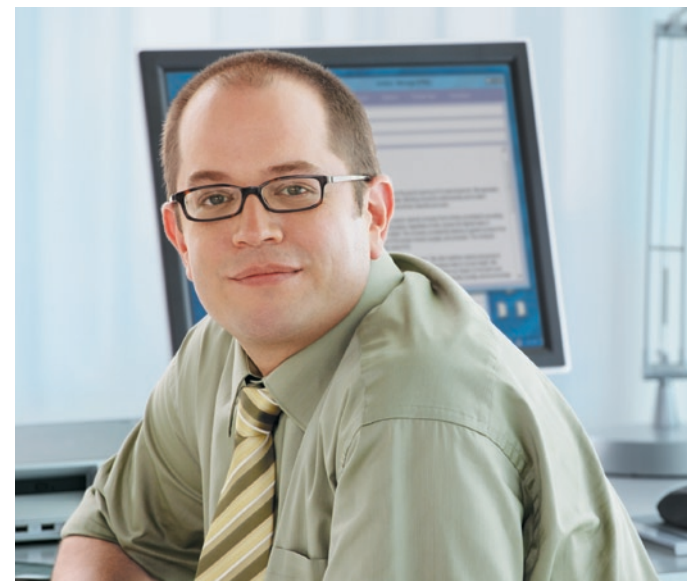

### Intel® Server Essentials has the answer

The family of Intel Server Essentials solutions, available with Intel® Server products, includes:

- **Intel® Server Deployment Toolkit (CD)**

With Intel® Deployment Assistant and other system utilities and drivers

- **Intel® System Management Software 3.0 (DVD)**

With Microsoft® System Center Essentials 2007 SP1, Intel® Management Packs, Intel® Active System Console, and other system utilities

- **Intel® Remote Management Module 2 (Intel® RMM2)**

An optional accessory available for selected Intel Server products

### The IT challenge

Businesses of all sizes want to upgrade their technology and automate processes so they can reduce costs and increase productivity. However, getting new systems set up can be a hassle, especially for SMBs that have:

- Small or part-time IT staff
- Limited budgets for software and hardware expenditures
- Low tolerance, time, and expertise for complicated IT solutions

Keeping pace with required changes while ensuring that systems perform optimally and remain secure can be overwhelming. Intel has a solution: software and hardware packages that are designed for small and midsize companies to fit their budget and address their specific challenges. Intel® Server Essentials simplifies management of the whole network and streamlines the full range of IT activities—from building and setting up servers to managing the IT environment—all from a single console.

## Fast Setup with Intel® Server Deployment Toolkit

Each Intel® Server Board ships with the Intel® Server Deployment Toolkit CD, which streamlines server setup and configuration. This toolkit includes the Intel® Deployment Assistant and additional configuration utilities.

### Intel® Deployment Assistant

Intel® Deployment Assistant reduces the complexity and time associated with setting up Intel® servers. Server deployment time is often cut by an hour or more per system, and even more time can be saved when using the cloning feature to deploy identical servers.

The wizard automatically locates and retrieves the latest drivers, BIOS, and firmware updates. It steps through questions allowing the user to quickly configure the server via automatic recognition of server hardware, minimal reboots, and an automated unattended OS installation.



#### FEATURES

Wizard-based user interface

Automatic detection of server configuration and components

Load configuration profiles for identical servers

Wizard-guided RAID configuration

Automatic detection of available software updates

Unattended OS installation

#### BENEFITS

Reduces complexity while providing comprehensive guidance in the deployment of Intel® servers.

Eliminates steps and saves time by detecting key configuration information including BIOS, LAN, and server management settings, and updating your system.

Reduces redundant tasks by saving and loading configuration settings from one server to identical servers.

Configures RAID from a single console with simple step-by-step instructions.

Minimizes uncertainty by automatically locating the latest drivers, firmware, and BIOS from the Internet, corporate network, or USB sources.

Saves time—simply answer configuration questions, choose the drivers to include, and pop in the operating system CD.

## Simplify with Intel® System Management Software 3.0

With 70 percent of IT costs tied to management and monitoring and only 30 percent tied to the cost of installation, centralizing and automating network or IT management tasks lowers management costs and enables scalability. Each Intel® server board ships with a copy of Intel® System Management Software 3.0, a comprehensive software suite designed to ease management of the entire IT environment through a single, unified console. Included with this powerful set of applications is Microsoft\* System Center Essentials 2007 (Essentials 2007), designed to specifically address IT management for small to midsize businesses with up to 30 servers and 500 clients. More than just a dashboard with data, the Essentials 2007 console provides expert knowledge for solving problems, tools for streamlining daily activities, and reports and tips that help IT staff efficiently monitor and maintain network health and security. Intel System Management Software 3.0 also comes with Intel® Server Management Packs. These hardware management packs complement Essentials 2007 with specific support of Intel server features—enabling maximum control and monitoring of these servers.

## Microsoft\* System Center Essentials 2007

With Essentials 2007, IT staffers at small and midsize businesses are no longer slowed down by using more than one application to get the IT management job done.

Through a single console, Essentials 2007 unifies:

- Problem detection and troubleshooting for all aspects of the network
- Service-level monitoring of business critical applications such as e-mail
- Asset tracking and reporting for simple, up-to-the-minute inventory information
- Security updates and patching of the OS, applications, and hardware
- Remote software distribution and installation of applications on servers and clients

System Center Essentials just got better and faster: Service Pack 1 improvements include up to 70 percent less memory consumption, faster console, support for workgroup-joined computers, SNMPv1 devices, improved setup, new update approval rules, enhanced third-party update experience, and support for Windows\* Server 2008.

This unified experience increases productivity and reduces costs because IT staff can save time by performing a broad set of daily and maintenance tasks from a single console. Reports, alerts, and automated patches help keep the IT environment up-to-date and more secure.

## Intel® Server Management Packs

Intel Server Management Packs are hardware management packs for Intel servers, enabling administrators to efficiently monitor Intel and LSI\* RAID, chassis and baseboard sensors including temperature, fan status, and voltage levels through an integrated management console. It works seamlessly with Essentials 2007 providing the best possible monitoring of overall system health using the technical details that help keep the server hardware healthy and stable.

### Microsoft\* System Center Essentials 2007

Features	Benefits
Single, easy-to-use console	Increases productivity and saves time by centralizing tasks on a single console to manage servers, clients, and other IT assets.
Proactive management	Identifies problems before they impact end users, provides expert knowledge when problems occur, reduces troubleshooting time, and helps get systems up and running.
Automated hardware and software inventories	Improves asset planning, management, and compliance through automated hardware and software inventories.
Automated updates, alerts, and reports	Lowers risks and reduces downtime with an easy-to-use interface that automatically monitors software and hardware components and alerts administrators of critical issues.
Wizards and templates	Saves time and reduces confusion with built-in intelligence provided by wizards and templates that simplify tasks.
Online training videos and context-sensitive help	Provides training and help on demand—no need to schedule and attend classes.

## Intel® Active System Console

Intel® Active System Console is a light-weight walkup console for customers that do not need all the features and functionality of System Center Essentials. This console will provide basic monitoring capabilities including server health and BMC configuration.

## Finding the Right Fit

For small to midsize businesses, one of the most costly aspects of IT departments, in terms of money, resources, and productivity, is managing PCs, servers, and software on the network. Many critical IT tasks, such as patches, updates, and daily maintenance, must be performed during work hours when they interrupt employees or cause server downtime. At the same time, you need to physically visit PCs and servers when systems cannot be located, diagnosed, repaired, or remediated down the wire.

Intel® System Management Software is specifically designed for IT professionals in small to midsize businesses who often face IT challenges similar to those of larger enterprises—troubleshooting end-user problems, automating management tasks, managing multiple systems, and diagnosing and resolving IT problems—but who don't have the luxury of a full staff of specialists.

Intel offers several different licensing options for the Intel System Management Software with Microsoft\* System Center Essentials 2007 ranging from a single server license to a combination of server and client licenses to manage up to 30 servers and 500 clients. Add licenses to the Single Server Edition that ships with the Intel® server boards and systems to meet your specific needs.

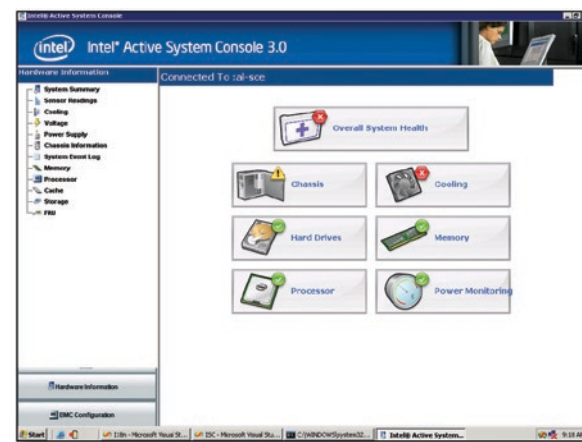

EDITION	DESCRIPTION	AVAILABLE FROM	ORDER INFORMATION
<b>Single Server Edition</b>	Microsoft* System Center Essentials 2007 with one server license	Shipped exclusively with Intel® server boards and systems	Ships with Intel server boards and system at no additional charge as an integrated part of the Intel® System Management Software offering
<b>Small Network Edition</b>	Adds 5 server and 15 client management licenses to the Single Server Edition	From Intel or authorized resellers and OEMs	<b>SMS2SSE2SNE</b> Upgrade from Single Server Edition to Small Network Edition
<b>Standard Edition Upgrade</b>	Adds 10 server and 50 client management licenses to the Single Server Edition and can be scaled to manage up to 30 servers and 500 clients with the purchase of additional client and server management licenses	From Intel or authorized resellers and OEMs	<b>SMS2SNE2STD</b> Upgrade from Small Network Edition to Standard Edition <b>SMS2SSE2STD</b> Upgrade from Single Server Edition to Standard Edition
<b>Client Management License</b>	Adds client management licenses in either 5 or 20 increments	From Intel or authorized resellers and OEMs	<b>SMS2CAL5C</b> Microsoft System Center Essentials 2007 Client Management License (5 Pack) <b>SMS2CAL20C</b> Microsoft System Center Essentials 2007 Client Management License (20 Pack)
<b>Server Management License</b>	Adds server management licenses in either 1 or 5 increments	From Intel or authorized resellers and OEMs	<b>SMS2CAL1S</b> Microsoft System Center Essentials 2007 Server Management License (1 Pack) <b>SMS2CAL5S</b> Microsoft System Center Essentials 2007 Server Management License (5 Pack)

## Get peace of mind

Intel® Server Essentials improves security, reduces costs, and helps businesses move from reactive to proactive system management. A mix of hardware and software enables secure remote management and monitoring of servers, clients, and applications from virtually any location—in a way that IT generalists can understand without attending weeks of training. It's all about IT made easy:

### Simple

- Makes it easy to set up and maintain a reliable and secure IT infrastructure
- Streamlines tasks throughout server life cycle with remote management
- Manages IT functions with a single suite of tools
- Reduces travel time and onsite service calls with remote monitoring

### Secure

- Keeps IT informed with automated daily health reports and alerts
- Delivers the power of Microsoft\* System Center Essentials 2007 for streamlining daily management activities
- Improves reliability and stability with rapid application and patch deployment

### Smart

- Designed specifically for small to midsize business
- Reduces travel time and costs
- Provides a proactive solution to server management with reports and alerts



For more information, visit the Intel Web site at: [www.intel.com/go/serveressentials](http://www.intel.com/go/serveressentials)

Features and Functions of Microsoft\* System Center Essentials 2007 and the Intel® Management Packs are dependent on the features and functions available on the server and client hardware and the loaded software and operating systems. Not all features and functions are available on all products and may require Intel® AMT or IPMI technologies for additional functionality. Intel and the Intel logo are trademarks of Intel Corporation in the U.S. and other countries.

\*Other names and brands may be claimed as the property of others.

Copyright © 2008 Intel Corporation. All rights reserved. 1008/RR/MS Part Number: 319436-003US **October 2008**



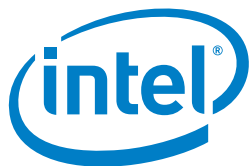

# INTEL® SERVER CHASSIS



## Intel® Server Chassis SC5400

Maximum reliability, scalability, and manageability in a highly versatile Intel® server chassis

Configuration	Base	BRP	LX	LXI
<b>Chassis Order Code<sup>1</sup></b>	<b>SC5400BASE SC5400BASENA</b>	<b>SC5400BRP SC5400BRPNA</b>	<b>SC5400LX SC5400LXNA</b>	<b>SC5400LXI SC5400LXINA</b>
<b>Spares Kit Order Code</b>	Maintenance kit: ARIG2PMKIT	Maintenance kit: ARIG2PMKIT	Maintenance kit: ARIG2PMKIT	Maintenance kit: ARIG2PMKIT
<b>Form Factor</b>	Pedestal or 5U rack <i>(Requires rack conversion kit ARIGRACK)</i>	Pedestal or 5U rack <i>(Requires rack conversion kit ARIGRACK)</i>	Pedestal or 5U rack <i>(Requires rack conversion kit ARIGRACK)</i>	Pedestal or 5U rack <i>(Requires rack conversion kit ARIGRACK)</i>
<b>Intel® Server Board Support<sup>2</sup></b>	<b>Intel® Server Boards S5000PSL and S5000XVN</b>	<b>Intel® Server Board S5000PSL</b>	<b>Intel® Server Board S5000PSL</b>	<b>Intel® Server Board S5000PSL</b>
<b>Drive Bays</b>	One tool-less fixed drive bay for up to six fixed drives Optional hot-swap/tool-less drive bays available: 6-drive SAS/SATA	One tool-less fixed drive bay for up to six fixed drives Optional hot-swap/tool-less drive bays available: 6-drive SAS/SATA, 4-drive SAS/SATA Optional 4-drive tool-less fixed drive bay	One tool-less fixed drive bay for up to six fixed drives Optional hot-swap/tool-less drive bays available: 6-drive SAS/SATA, 4-drive SAS/SATA Optional 4-drive tool-less fixed drive bay	Includes one hot-swap 6-drive SAS/SATA drive bay—AXX6DRV3G
<b>Hot-Swap Disk Drive Bay: Order Code</b>	Up to six hot-swap drive bays via the following hot-swap disk drive bay upgrade kits: 6-drive SAS/SATA—AXX6DRV3G 6-drive SAS/SATA Expander—AXX6DRV3GEXP	Up to ten hot-swap drive bays are possible with the combination of the following drive bay upgrade kits: 6-drive SAS/SATA—AXX6DRV3G 6-drive SAS/SATA Expander—AXX6DRV3GEXP 4-drive SAS/SATA—AXX4DRV3G 4-drive SAS/SATA Expander—AXX4DRV3GEXP	Up to ten hot-swap drive bays are possible with the combination of the following drive bay upgrade kits: 6-drive SAS/SATA—AXX6DRV3G 6-drive SAS/SATA Expander—AXX6DRV3GEXP 4-drive SAS/SATA—AXX4DRV3G 4-drive SAS/SATA Expander—AXX4DRV3GEXP	Up to ten hot-swap drives are possible with the combination of the following drive bay upgrade kits: 4-drive SAS/SATA—AXX4DRV3G 4-drive SAS/SATA Expander—AXX4DRV3GEXP
<b>System Cooling</b>	Includes two system fans plus one power supply fan	Includes two system fans plus one power supply fan	Supports redundant cooling with four high-flow system fans plus up to two power supply fans	Supports hot-swap, redundant cooling with four high-flow system fans plus two power supply fans
<b>Power Supply</b>	670-watt PFC	830-watt, dual-line cord, 1+1 PFC	830-watt, dual-line cord, 1+1 PFC	830-watt, dual-line cord, 1+1 PFC <i>(Two included in the chassis)</i>
<b>Redundant Power Capable</b>	Yes <i>(via upgrade kit)</i>	Yes <i>(fully redundant configuration requires second power module FXX830WPSU)</i>	Yes <i>(fully redundant configuration requires second power module FXX830WPSU)</i>	Yes, second, fully redundant power supply <i>(FXX830WPSU)</i> included.
<b>Tool-less Features</b>	Fixed hard drive install and removal, fixed or hot-swap drive bays, 5.25 peripheral install and removal, optional rack rails, optional cable management arm	Fixed hard drive install and removal, fixed or hot-swap drive bays, 5.25 peripheral install and removal, optional rack rails, optional cable management arm	Fixed hard drive install and removal, fixed or hot-swap drive bays, 5.25 peripheral install and removal, cooling fans, optional rack rails, optional cable management arm	Hot-swap drive bays, 5.25 peripheral install and removal, cooling fans, optional rack rails, optional cable management arm
<b>Dimensions (H x W x D)</b>	17.5" (445mm) x 8.6" (218mm) x 26.9" (683mm)	17.5" (445mm) x 8.6" (218mm) x 26.9" (683mm)	17.5" (445mm) x 8.6" (218mm) x 26.9" (683mm)	17.5" (445mm) x 8.6" (218mm) x 26.9" (683mm)
<b>Bezel Features</b>	Lockable, Black, Support for Intel® Local Control Panel: AXXLCPPED	Lockable, Black, Support for Intel® Local Control Panel: AXXLCPPED	Lockable, Black, Support for Intel® Local Control Panel: AXXLCPPED	Lockable, Black, Support for Intel® Local Control Panel: AXXLCPPED
<b>Front Connectors</b>	2 x USB 1 x Serial	2 x USB 1 x Serial	2 x USB 1 x Serial	2 x USB 1 x Serial



**Intel® Server Chassis  
SC5299-E**

*A reliable, quiet, and flexible server chassis for entry-level server and workstation applications*



**Intel® Server Chassis  
SC5295-E**

*A reliable and flexible server chassis for entry-level server and workstation applications*

Configuration	WS	BRP	DP	UP	UP
<b>Chassis Order Code<sup>1</sup></b>	<b>SC5299WS SC5299WSNA</b>	<b>SC5299BRP SC5299BRPNA</b>	<b>SC5299DP SC5299DPNA</b>	<b>SC5299UP SC5299UPNA</b>	<b>SC5295UP SC5295UPNA</b>
<b>Spares Kit Order Code</b>	Maintenance kit: FPP4PMKIT	Maintenance kit: FPP4PMKIT	Maintenance kit: FPP4PMKIT	Maintenance kit: FPP4PMKIT	Maintenance kit: FPP3PMKIT
<b>Form Factor</b>	Pedestal and Rack	Pedestal and Rack	Pedestal and Rack	Pedestal and Rack	Pedestal and Rack
<b>Intel® Server Board Support<sup>2</sup></b>	<b>Intel® Server Board S5000XVN</b>	<b>Intel® Server Boards S5000PSL and S5000VSA</b>	<b>Intel® Server Boards S5000PSL and S5000VSA</b>	<b>Intel® Server Boards S3210SHLX, S3210SHLC, and S3200SHV</b>	<b>Intel® Server Board Server Board S3000AH, S3000AHLX, and S3000AHV</b>
<b>Drive Bays</b>	6 x fixed hard drives 1 x 3.5" floppy 2 x 5.25" bays	6 x fixed hard drives 1 x 3.5" floppy 2 x 5.25" bays	6 x fixed hard drives 1 x 3.5" floppy 2 x 5.25" bays	6 x fixed hard drives 1 x 3.5" floppy 2 x 5.25" bays	6 x fixed hard drives 1 x 3.5" floppy 2 x 5.25" bays
<b>Hot-Swap Disk Drive Bay: Order Code</b>	Optional six hot-swap drive bays via one of the following hot-swap disk drive bay upgrade kits: 6-drive SAS/SATA Expander—AXX6DRV3GEXP 6-drive SAS/SATA—AXX6DRV3G	One fixed drive bay for up to six fixed drives Optional six hot-swap drive bays via one of the following hot-swap disk drive bay upgrade kits: 6-drive SAS/SATA Expander—AXX6DRV3GEXP 6-drive SAS/SATA—AXX6DRV3G	One fixed drive bay for up to six fixed drives Optional six hot-swap drive bays via one of the following hot-swap disk drive bay upgrade kits: 6-drive SAS/SATA Expander—AXX6DRV3GEXP 6-drive SAS/SATA—AXX6DRV3G	One fixed drive bay for up to six fixed drives Optional six hot-swap drive bays via one of the following hot-swap disk drive bay upgrade kits: 6-drive SAS/SATA Expander—AXX6DRV3GEXP 6-drive SAS/SATA—AXX6DRV3G	N/A
<b>System Cooling</b>	One tool-less system fan and one fixed drive bay cooling fan	One tool-less system fan	One tool-less system fan	One tool-less system fan	One fixed system fan, plus one power supply fan
<b>Power Supply</b>	670-watt PFC	650-watt 1+1 PFC	550-watt PFC	420-watt PFC	350-watt PFC
<b>Redundant Power Capable</b>	No	Yes (Optional second power supply sold separately)	No	Yes	No
<b>Tool-less Features</b>	Peripheral bays, fixed hard drive bay, optional hot-swap bays, system fan, PCI slots	Peripheral bays, fixed hard drive bay, optional hot-swap bays, power supplies, system fan, PCI slots	Peripheral bays, fixed hard drive bay, optional hot-swap bays, system fan, PCI slots	Peripheral bays, fixed hard drive bay, optional hot-swap bays, system fan, PCI slots	Chassis side cover, peripheral bays, fixed hard drive bay, optional hot-swap bays, power supplies, system fan, PCI slots
<b>Pedestal Dimensions (H x W x D)</b>	17.8" (452mm) x 9.256" (235mm) x 19" (483mm)	17.8" (452mm) x 9.256" (235mm) x 19" (483mm)	17.8" (452mm) x 9.256" (235mm) x 19" (483mm)	17.8" (452mm) x 9.256" (235mm) x 19" (483mm)	17.8" (452mm) x 9.256" (235mm) x 19" (483mm)
<b>Rack Dimensions (H x W x D)</b>	9.256" (235mm) x 17.6" (447mm) x 19" (483mm)	9.256" (235mm) x 17.6" (447mm) x 19" (483mm)	9.256" (235mm) x 17.6" (447mm) x 19" (483mm)	9.256" (235mm) x 17.6" (447mm) x 19" (483mm)	9.256" (235mm) x 17.6" (447mm) x 19" (483mm)
<b>Bezel Features</b>	Lockable, Black, Support for Intel® Local Control Panel: AXXLCPED	Lockable, Black, Support for Intel® Local Control Panel: AXXLCPED	Lockable, Black, Support for Intel® Local Control Panel: AXXLCPED	Lockable, Black	Lockable, Black, Support for Intel® Local Control Panel: AXXLCPED
<b>Front Connectors</b>	2 x USB	2 x USB	2 x USB	2 x USB	2 x USB

<sup>1</sup> North American power cord included in order codes ending in NA; power cord not included in all other order codes.

<sup>2</sup> Refer to <http://support.intel.com/support/motherboards/server> for up-to-date details on server boards supported by each chassis.

All products and dates specified are preliminary based on current expectations and are subject to change without notice. Availability in different channels may vary.

Intel and the Intel logo are trademarks of Intel Corporation in the U.S. and other countries.

\*Other names and brands may be claimed as the property of others.

Copyright © 2008 Intel Corporation. All rights reserved. 1008/RR/MS Part Number: 252628-023US **October 2008**



## INTEL® SERVER SYSTEMS



System	Intel® Server System SR1560SF	Intel® Server System SR1560SFHS	Intel® Server System SR1500AL
	<i>1U rack-optimized server system for high-performance and high-density computing</i>	<i>1U rack-optimized server system for high-performance and high-density computing</i>	<i>1U rack-optimized server system for flexible high-density server solutions</i>
<b>Order Code<sup>1</sup></b>	<b>SR1560SF</b>	<b>SR1560SFHS</b>	<b>SR1500ALR</b>
<b>Components Included</b>	<ul style="list-style-type: none"> <li>Intel® Server Board S5400SF</li> <li>Intel® Server Chassis SR1560</li> <li>One PCI Express* x16 riser card supporting full-height/full-length add-in card</li> <li>Standard control panel</li> <li>Pre-routed cables</li> </ul>	<ul style="list-style-type: none"> <li>Intel® Server Board S5400SF</li> <li>Intel® Server Chassis SR1560</li> <li>One PCI Express* x16 riser card supporting full-height/full-length add-in card</li> <li>Standard control panel</li> <li>Pre-routed cables</li> </ul>	<ul style="list-style-type: none"> <li>Intel® Server Board S5000PALR</li> <li>Intel® Server Chassis SR1500</li> <li>One low-profile PCI Express* riser, one full-height/full-length PCI Express riser</li> <li>Passive SAS/SATA backplane</li> <li>Standard control panel</li> <li>Pre-routed cables</li> </ul>
<b>Number of Processors Supported</b>	2	2	2
<b>Processor Support<sup>2</sup></b>	<b>Multi-Core Intel® Xeon® processor</b>	<b>Multi-Core Intel® Xeon® processor</b>	<b>Multi-Core Intel® Xeon® processor</b>
<b>System Bus Speed</b>	1600 MHz <sup>4</sup> / 1333 MHz / 1066 MHz	1600 MHz <sup>4</sup> / 1333 MHz / 1066 MHz	1333 MHz <sup>5</sup> / 1066 MHz / 667 MHz
<b>Chipset</b>	Intel® 5400 Chipset	Intel® 5400 Chipset	Intel® 5000P Chipset
<b>PCI Buses</b>	4	4	4
<b>Total Slots</b>	1	1	2
<b>Slot Types</b>	1 x PCI Express 2.0 x16 (2nd Gen PCIe) Optional Intel® I/O Expansion Module (Ext 4-port SAS; Dual Port GigE; IB)	1 x PCI Express 2.0 x16 (2nd Gen PCIe) Optional Intel® I/O Expansion Module (Ext 4-port SAS; Dual Port GigE; IB)	2 x PCI Express x8 Optional Support: 1 x PCI-X 133 MHz plus Intel® I/O Expansion Module
<b>Memory Capacity</b>	64 GB ECC Fully Buffered DDR2 (16 DIMMs)	64 GB ECC Fully Buffered DDR2 (16 DIMMs)	32 GB ECC Fully Buffered DDR2 (8 DIMMs)
<b>Backplane</b>	None – Fixed Mount SATA Drive Support Only Server board has Intel® Embedded Server RAID Technology II via the ESB2 SATA controller providing RAID 0, 1, and 10.	Active SAS/SATA backplane with integrated LSI* 1064E SAS controller with Intel® Embedded Server RAID Technology II providing RAID 0,1, and 10 and optional RAID 5. Passive SATA backplane using ESB2 SATA controller from server board with Intel Embedded Server RAID Technology II via the ESB2 SATA controller providing RAID 0, 1, and 10 with optional RAID 5 support.	Hot-swap SAS/SATA passive backplane. Server board has Intel® Embedded Server RAID Technology II via the ESB2 SATA controller providing RAID 0, 1, and 10 with optional AXXRAKSw5 for RAID 5.
<b>Integrated LAN</b>	2 x Intel® Gigabit Ethernet Controller	2 x Intel® Gigabit Ethernet Controller	2 x Intel® Gigabit Ethernet Controller
<b>Integrated Graphics</b>	ATI* with 32 MB memory	ATI* with 32 MB memory	ATI* with 16 MB memory
<b>Server Management Support</b>	Intel® Server Essentials 2.0 Intelligent Platform Management Interface 2.0 Support for Intel® Remote Management Module (AXXRMM2)	Intel® Server Essentials 2.0 Intelligent Platform Management Interface 2.0 Support for Intel® Remote Management Module (AXXRMM2)	Intel® Server Essentials 2.0 Intelligent Platform Management Interface 2.0 Support for Intel® Remote Management Module (AXXRMM2)
<b>Intel® RAID Controller Compatibility (Order Code)<sup>3</sup></b>	SRCS28X SRCS16 SRCSAS18E	SRCS28X SRCS16 SRCSAS18E	SRCS28X SRCS16 SRCSAS18E
<b>Form Factor</b>	1U Rack	1U Rack	1U Rack
<b>Drive Bays</b>	2 x fixed SATA 1 x slim-line IDE Optical Drive	3 x Hot-Swap SATA/SAS (requires backplane option—Active SAS or Passive SATA) 1 x slim-line IDE Optical Drive or USB-Floppy drive	3 x hot-swap SAS/SATA Optional slim-line CD-ROM/USB-Floppy
<b>System Cooling</b>	Supports five managed system fans + two power supply fans	Supports five managed system fans + two power supply fans	Supports five system fans
<b>Power Supply</b>	600-watt, non-redundant, high efficiency, PFC	600-watt, non-redundant, high efficiency, PFC	600-watt, non-redundant PFC
<b>Dimensions (H x W x D)</b>	1.703" (43mm) x 16.93" (430mm) x 27.25" (692mm)	1.703" (43mm) x 16.93" (430mm) x 27.25" (692mm)	1.703" (43mm) x 16.93" (430mm) x 27.25" (692mm)

For more information, visit the Intel Web site at: [www.intel.com/go/serversystems](http://www.intel.com/go/serversystems)



System	Intel® Server System SR1500ALSAS	Intel® Server System SR1550AL	Intel® Server System SR1550ALSAS
	1U rack-optimized server system for flexible high-density server solutions	1U rack-optimized server system for flexible high-density server solutions with optional power redundancy	1U rack-optimized server system for flexible high-density server solutions with optional power redundancy
Order Code <sup>1</sup>	<b>SR1500ALSASR</b>	<b>SR1550ALR</b>	<b>SR1550ALSASR</b>
Components Included	<ul style="list-style-type: none"> <li>Intel® Server Board S5000PALR</li> <li>Intel® Server Chassis SR1500</li> <li>One low-profile PCI Express* riser, one full-height/full-length PCI Express riser</li> <li>SAS/SATA backplane with integrated SAS Controller</li> <li>Standard control panel</li> <li>Pre-routed cables</li> </ul>	<ul style="list-style-type: none"> <li>Intel® Server Board S5000PALR</li> <li>Intel® Server Chassis SR1550</li> <li>One low-profile PCI Express* riser, one full-height/full-length PCI Express riser</li> <li>Passive SAS/SATA midplane</li> <li>Standard control panel</li> <li>Pre-routed cables</li> <li>1 (of 2) 650-watt power supplies</li> </ul>	<ul style="list-style-type: none"> <li>Intel® Server Board S5000PALR</li> <li>Intel® Server Chassis SR1550</li> <li>One low-profile PCI Express* riser, one full-height/full-length PCI Express riser</li> <li>SAS/SATA midplane with integrated 8 port SAS Controller</li> <li>Standard control panel</li> <li>Pre-routed cables</li> <li>1 (of 2) 650-watt power supplies</li> </ul>
Number of Processors Supported	2	2	2
Processor Support <sup>2</sup>	<b>Multi-Core Intel® Xeon® processor</b>	<b>Multi-Core Intel® Xeon® processor</b>	<b>Multi-Core Intel® Xeon® processor</b>
System Bus Speed	1333 MHz <sup>5</sup> / 1066 MHz / 667 MHz	1333 MHz <sup>5</sup> / 1066 MHz / 667 MHz	1333 MHz <sup>5</sup> / 1066 MHz / 667 MHz
Chipset	Intel® 5000P Chipset	Intel® 5000P Chipset	Intel® 5000P Chipset
PCI Buses	4	4	4
Total Slots	2	2	2
Slot Types	2 x PCI Express x8 Optional Support: 1 x PCI-X 133 MHz plus Intel® I/O Expansion Module	2 x PCI Express x8 Optional Support: 1 x PCI-X 133 MHz plus Intel® I/O Expansion Module	2 x PCI Express x8 Optional Support: 1 x PCI-X 133 MHz plus Intel® I/O Expansion Module
Memory Capacity	32 GB ECC Fully Buffered DDR2 (8 DIMMs)	32 GB ECC Fully Buffered DDR2 (8 DIMMs)	32 GB ECC Fully Buffered DDR2 (8 DIMMs)
Backplane	Hot-swap SAS/SATA backplane with Intel® Embedded Server RAID Technology II via a 4-port SAS controller providing RAID 0, 1, and 10 with optional AXXRAKSW5 for RAID 5.	Hot-swap SAS/SATA passive midplane. Server board has Intel® Embedded Server RAID Technology II via the ESB2 SATA controller providing RAID 0, 1, and 10.	SAS/SATA midplane with Intel® Integrated Server RAID module. Capable of RAID 0, 1, and 10. With AXXRAK18E and AXXMINIDIMM provides intelligent RAID 0, 1, 5, 10, and 50. Optional chassis mount Intel® RAID Smart Battery.
Integrated LAN	2 x Intel® Gigabit Ethernet Controller	2 x Intel® Gigabit Ethernet Controller	2 x Intel® Gigabit Ethernet Controller
Integrated Graphics	ATI* with 16 MB memory	ATI* with 16 MB memory	ATI* with 16 MB memory
Server Management Support	Intel® Server Essentials 2.0 Intelligent Platform Management Interface 2.0 Support for Intel® Remote Management Module (AXXRRMM2)	Intel® Server Essentials 2.0 Intelligent Platform Management Interface 2.0 Support for Intel® Remote Management Module (AXXRRMM2)	Intel® Server Essentials 2.0 Intelligent Platform Management Interface 2.0 Support for Intel® Remote Management Module (AXXRRMM2)
Intel® RAID Controller Compatibility <sup>3</sup>	Includes Intel® Embedded RAID Technology and upgradable to full-featured integrated RAID, and compatible with Intel® RAID Controllers	Includes Intel® Embedded RAID Technology and compatible with Intel® RAID Controllers	Includes Intel® Embedded RAID Technology and upgradable to full-featured integrated RAID, and compatible with Intel® RAID Controllers
Form Factor	1U Rack	1U Rack	1U Rack
Drive Bays	3 x hot-swap SAS/SATA Optional slim-line CD-ROM/USB-Floppy	Up to 8 x 2.5" hot-swap SAS/SATA Optional slim-line CD-ROM	Up to 8 x 2.5" hot-swap SAS/SATA Optional slim-line CD-ROM
System Cooling	Supports five system fans	Supports five system fans	Supports five system fans
Power Supply	600-watt, non-redundant PFC	650-watt, dual-line cord 1+1 PFC (fully redundant configuration requires second power module, order code ASR1550PS)	650-watt, dual-line cord 1+1 PFC (fully redundant configuration requires a second power module, order code ASR1550PS)
Dimensions (H x W x D)	1.703" (43mm) x 16.93" (430mm) x 27.25" (692mm)	1.703" (43mm) x 16.93" (430mm) x 25.76" (654mm)	1.703" (43mm) x 16.93" (430mm) x 25.76" (654mm)



System Order Code <sup>1</sup>	Intel® Server System SR2500ALBRP	Intel® Server System SR2500ALLX	Intel® Server System SR1530AHLX
<b>Components Included</b>	<ul style="list-style-type: none"> <li>Intel® Server Board S5000PALR</li> <li>Intel® Server Chassis SR2500</li> <li>One 2 slot low-profile PCI Express* riser, one full-height/full-length PCI Express/PCI-X riser</li> <li>Passive SAS/SATA midplane</li> <li>Standard control panel</li> <li>Pre-routed cables</li> <li>1 (of 2) 750-watt power supplies</li> </ul>	<ul style="list-style-type: none"> <li>Intel® Server Board S5000PALR</li> <li>Intel® Server Chassis SR2500</li> <li>One 2 slot low-profile PCI Express* riser, one full-height/full-length PCI Express/PCI-X riser</li> <li>SAS/SATA midplane with integrated 8 port SAS Controller</li> <li>Standard control panel</li> <li>Pre-routed cables</li> <li>1 (of 2) 750-watt power supplies</li> </ul>	<ul style="list-style-type: none"> <li>Intel® Server Board S3000AHLX</li> <li>Intel® Server Chassis with 350-watt power supply</li> <li>System fan and cooling blowers with duct</li> <li>Intel® 1U heatsink</li> <li>Slim-line CD-ROM bay</li> <li>Basic rail kit</li> <li>Pre-routed cables</li> </ul>
<b>Number of Processors Supported</b>	2	2	1
<b>Processor Support<sup>2</sup></b>	<b>Multi-Core Intel® Xeon® processor</b>	<b>Multi-Core Intel® Xeon® processor</b>	<b>Multi-Core Intel® Xeon®, Intel® Pentium® D, Intel® Pentium® Extreme Edition, Intel® Pentium® 4, and Intel® Celeron® D processors</b>
<b>System Bus Speed</b>	1333 MHz <sup>5</sup> / 1066 MHz / 667 MHz	1333 MHz <sup>5</sup> / 1066 MHz / 667 MHz	1066 MHz / 800 MHz / 533 MHz
<b>Chipset</b>	Intel® 5000P Chipset	Intel® 5000P Chipset	Intel® 3000 Server Chipset
<b>PCI Buses</b>	4	4	6
<b>Total Slots</b>	5	5	1
<b>Slot Types</b>	3 full-height, full-length slots; 1 x PCI-X 133 MHz plus Intel® I/O Expansion Module, 2 x PCI Express. 2 low-profile PCI Express	3 full-height, full-length slots; 1 x PCI-X 133 MHz plus Intel® I/O Expansion Module, 2 x PCI Express. 2 low-profile PCI Express	1 x PCI Express* x8 or 1 x PCI-X 133 MHz
<b>Memory Capacity</b>	32 GB ECC Fully Buffered DDR2 (8 DIMMs)	32 GB ECC Fully Buffered DDR2 (8 DIMMs)	4 x DIMM slots for DDR2 533/667 MHz Unbuffered ECC/non-ECC DIMMs (8 GB Max)
<b>Integrated SCSI</b>	Hot-swap Passive SAS/SATA midplane with Intel® Embedded Server RAID Technology II available from the 6-port ESB2 SATA controller providing RAID 0, 1, and 10.	SAS/SATA midplane with Intel® Integrated Server RAID module. Capable of RAID 0, 1, and 10. With AXXRAK18E and AXXMINDIMM provides intelligent RAID 0, 1, 5, 10, and 50. Optional chassis mount Intel® RAID Smart Battery.	No
<b>Integrated LAN</b>	2 x Intel® Gigabit Ethernet Controller	2 x Intel® Gigabit Ethernet Controller	2 x Intel® Gigabit Ethernet Controller
<b>Integrated Graphics</b>	ATI* with 16 MB memory	ATI* with 16 MB memory	ATI* with 16 MB memory
<b>Server Management Support</b>	Intel® Server Essentials 2.0 Intelligent Platform Management Interface 2.0 Support for Intel® Remote Management Module (AXXRMM2)	Intel® Server Essentials 2.0 Intelligent Platform Management Interface 2.0 Support for Intel® Remote Management Module (AXXRMM2)	Intel® Server Essentials 2.0
<b>Intel® RAID Controller Compatibility<sup>3</sup></b>	Includes Intel® Embedded RAID Technology and compatible with Intel® RAID Controllers	Includes Intel® Embedded RAID Technology and upgradable to full-featured integrated RAID, and compatible with Intel® RAID Controllers	Includes Intel® Embedded RAID Technology and compatible with Intel® RAID Controllers
<b>Form Factor</b>	2U Rack	2U Rack	1U Rack
<b>Drive Bays</b>	Up to 6 x hot-swap SAS/SATA Optional slim-line CD-ROM/USB-Floppy	Up to 6 x hot-swap SAS/SATA Optional slim-line CD-ROM/USB-Floppy	2 x fixed 3.5" SATA (3.0 Gb/s) HDDs 1 x fixed slim-line CD-ROM
<b>System Cooling</b>	Supports three system fans	Supports six system fans (redundant and hot-swappable)	2 x fixed cooling blowers with duct 1 x system fan
<b>Power Supply</b>	750-watt, dual-line cord 1+1 PFC (Fully redundant configuration requires a second power module, order code ASR2500PS)	750-watt, dual-line cord 1+1 PFC (Fully redundant configuration requires a second power module, order code ASR2500PS)	350-watt PFC power supply
<b>Dimensions (H x W x D)</b>	3.44" (87mm) x 16.93" (430mm) x 27.95" (710mm)	3.44" (87mm) x 16.93" (430mm) x 27.95" (710mm)	1.70" (43mm) x 16.9" (430mm) x 20.0" (508mm)



System Order Code <sup>1</sup>	Intel® Server System SR1530AH	Intel® Server System SR1530HAHLX	Intel® Server System SR1530CLR	Intel® Server System SR1530HCL
<b>Components Included</b>	<b>SR1530AH</b> <b>SR1530AHNA</b> <ul style="list-style-type: none"> <li>Intel® Server Board S3000AH</li> <li>Intel® Server Chassis with 350-watt power supply</li> <li>System fan and cooling blowers with duct</li> <li>Intel® 1U heatsink</li> <li>Slim-line CD-ROM bay</li> <li>Basic rail kit</li> <li>Pre-routed cables</li> </ul>	<b>SR1530HAHLX</b> <b>SR1530HAHLXNA</b> <ul style="list-style-type: none"> <li>Intel® Server Board S3000AHLX</li> <li>Intel® Server Chassis with 350-watt power supply</li> <li>System cooling blowers with duct</li> <li>Intel® 1U heatsink</li> <li>Slim-line CD-ROM bay</li> <li>Basic rail kit</li> <li>Pre-routed cables</li> </ul>	<b>SR1530CLR</b> <b>SR1530CLRNA</b> <ul style="list-style-type: none"> <li>Intel® Server Board S5000VCLR (SATA)</li> <li>Intel® Server Chassis SR1530</li> <li>400-watt non-redundant power supply</li> <li>One riser card supporting 2 PCI slots</li> <li>Slim-line CD-ROM bay</li> <li>Basic rail kit</li> <li>Pre-routed cables</li> </ul>	<b>SR1530HCLR</b> <b>SR1530HCLRNA</b> <ul style="list-style-type: none"> <li>Intel® Server Board S5000VCLR (SAS)</li> <li>Intel® Server Chassis SR1530H</li> <li>400-watt non-redundant power supply</li> <li>One riser card supporting 2 PCI slots</li> <li>Slim-line CD-ROM bay</li> <li>Basic rail kit</li> <li>Pre-routed cables</li> </ul>
<b>Number of Processors Supported</b>	1	1	2	2
<b>Processor Support<sup>2</sup></b>	Multi-Core Intel® Xeon®, Intel® Pentium® D, Intel® Pentium® Extreme Edition, Intel® Pentium® 4, and Intel® Celeron® D processors	Multi-Core Intel® Xeon®, Intel® Pentium® D, Intel® Pentium® Extreme Edition, Intel® Pentium® 4, and Intel® Celeron® D processors	Multi-Core Intel® Xeon® processor	Multi-Core Intel® Xeon® processor
<b>System Bus Speed</b>	1066 MHz / 800 MHz / 533 MHz	1066 MHz / 800 MHz / 533 MHz	1333 MHz <sup>5</sup> / 1066 MHz	1333 MHz <sup>5</sup> / 1066 MHz
<b>Chipset</b>	Intel® 3000 Server Chipset	Intel® 3000 Server Chipset	Intel® 5000V Chipset	Intel® 5000V Chipset
<b>PCI Buses</b>	6	6	4	4
<b>Total Slots</b>	1	1	2	2
<b>Slot Types</b>	1 x PCI Express* x8	1 x PCI Express* x8 or 1 x PCI-X 133 MHz	1 x low-profile PCI Express* x8 1 x full-height / mid-length PCI-X 133 MHz	1 x low-profile PCI Express* x8 1 x full-height / mid-length PCI-X 133 MHz
<b>Memory Capacity</b>	4 x DIMM slots for DDR2 533/667 MHz Unbuffered ECC/non-ECC DIMMs (8 GB Max)	4 x DIMM slots for DDR2 533/667 MHz Unbuffered ECC/non-ECC DIMMs (8 GB Max)	12 GB ECC Fully Buffered DDR2 (6 DIMMs)	12 GB ECC Fully Buffered DDR2 (6 DIMMs)
<b>Integrated SCSI</b>	No	No	No	No
<b>Integrated LAN</b>	2 x Intel® Gigabit Ethernet Controller	2 x Intel® Gigabit Ethernet Controller	2 x Intel® Gigabit Ethernet Controller	2 x Intel® Gigabit Ethernet Controller
<b>Integrated Graphics</b>	ATI* with 16 MB memory	ATI* with 16 MB memory	ATI* with 16 MB memory	ATI* with 16 MB memory
<b>Server Management Support</b>	Intel® Server Essentials 2.0	Intel® Server Essentials 2.0 Intelligent Platform Management Interface 2.0	Intel® Server Essentials 2.0 Intelligent Platform Management Interface 2.0	Intel® Server Essentials 2.0 Intelligent Platform Management Interface 2.0
<b>Intel® RAID Controller Compatibility<sup>3</sup></b>	Includes Intel® Embedded RAID Technology and compatible with Intel® RAID Controllers	Includes Intel® Embedded RAID Technology and compatible with Intel® RAID Controllers	Includes Intel® Embedded RAID Technology and compatible with Intel® RAID Controllers	Includes Intel® Embedded RAID Technology and compatible with Intel® RAID Controllers
<b>Form Factor</b>	1U Rack	1U Rack	1U Rack	1U Rack
<b>Drive Bays</b>	2 x fixed 3.5" SATA (3.0 Gb/s) HDDs 1 x fixed slim-line CD-ROM	3 x hot-swap 3.5" SATA (3.0 Gb/s) HDDs 1 x fixed slim-line CD-ROM	2 x fixed 3.5" SATA HDDs Optional slim-line optical drive	3 x hot-swap 3.5" SATA HDDs Optional slim-line CD-ROM drive
<b>System Cooling</b>	2 x fixed cooling blowers with duct 1 x system fan	2 x fixed cooling blowers with duct	2 x fixed cooling blowers with duct 1 x system fan	2 x fixed cooling blowers with duct 1 x system fan
<b>Power Supply</b>	350-watt PFC power supply	350-watt non-redundant	400-watt PFC non-redundant power supply	400-watt PFC non-redundant power supply
<b>Dimensions (H x W x D)</b>	1.70" (43mm) x 16.9" (430mm) x 20.0" (508mm)	1.70" (43mm) x 16.92" (430mm) x 25.51" (648mm)	1.70" (43mm) x 16.9" (430mm) x 20.0" (508mm)	1.70" (43mm) x 16.92" (430mm) x 25.51" (648mm)



System Order Code <sup>1</sup>	Intel® Server System SR1530HCLS	Intel® Server System SR2520SAF	Intel® Server System SR2520SAX	Intel® Server System SR2520SAXS
<b>Components Included</b>	<b>SR1530HCLSR</b> <b>SR1530HCLSRNA</b> <ul style="list-style-type: none"> <li>Intel® Server Board S5000VCLR (SAS)</li> <li>Intel® Server Chassis SR1530H</li> <li>400-watt non-redundant power supply</li> <li>One riser card supporting 2 PCI slots</li> <li>Slim-line CD-ROM bay</li> <li>Basic rail kit</li> <li>Pre-routed cables</li> </ul>	<b>SR2520SAFR</b> <b>SR2520SAFRNA</b> <ul style="list-style-type: none"> <li>Intel® Server Board S5000VSAR (4 DIMMs)</li> <li>Intel® Server Chassis SR2520</li> <li>600-watt non-redundant power supply</li> <li>System fan with duct</li> <li>CD and HDD assemblies</li> <li>Pre-routed cables</li> </ul>	<b>SR2520SAXR</b> <b>SR2520SAXRNA</b> <ul style="list-style-type: none"> <li>Intel® Server Board S5000VSAR (SATA)</li> <li>Intel® Server Chassis SR2520</li> <li>600-watt power supply (redundancy requires optional second power supply)</li> <li>System fan with duct</li> <li>CD and HDD assemblies</li> <li>Pre-routed cables</li> </ul>	<b>SR2520SAXSR</b> <b>SR2520SAXSRNA</b> <ul style="list-style-type: none"> <li>Intel® Server Board S5000VSAR (SAS)</li> <li>Intel® Server Chassis SR2520</li> <li>600-watt power supply (redundancy requires optional second power supply)</li> <li>System fan with duct</li> <li>CD and HDD assemblies</li> <li>Pre-routed cables</li> </ul>
<b>Number of Processors Supported</b>	2	2	2	2
<b>Processor Support<sup>2</sup></b>	<b>Multi-Core Intel® Xeon® processor</b>	<b>Multi-Core Intel® Xeon® processor</b>	<b>Multi-Core Intel® Xeon® processor</b>	<b>Multi-Core Intel® Xeon® processor</b>
<b>System Bus Speed</b>	1333 MHz <sup>5</sup> / 1066 MHz	1333 MHz <sup>5</sup> / 1066 MHz / 667 MHz	1333 MHz <sup>5</sup> / 1066 MHz / 667 MHz	1333 MHz <sup>5</sup> / 1066 MHz / 667 MHz
<b>Chipset</b>	Intel® 5000V Chipset	Intel® 5000V Chipset	Intel® 5000V Chipset	Intel® 5000V Chipset
<b>PCI Buses</b>	4	4	4	4
<b>Total Slots</b>	2	5	5	5
<b>Slot Types</b>	1 x low-profile PCI Express* x8 1 x full-height / mid-length PCI-X 133 MHz	2 x low-profile PCI Express* x4 (x8 Connector) 2 x low-profile PCI-X 64-bit 100/133 MHz 1 x low-profile PCI 32-bit 33 MHz	2 x low-profile PCI Express* x4 (x8 Connector) 2 x low-profile PCI-X 64-bit 100/133 MHz 1 x low-profile PCI 32-bit 33 MHz	2 x low-profile PCI Express* x4 (x8 Connector) 2 x low-profile PCI-X 64-bit 100/133 MHz 1 x low-profile PCI 32-bit 33 MHz
<b>Memory Capacity</b>	12 GB ECC Fully Buffered DDR2 (6 DIMMs)	8 GB ECC Fully Buffered DDR2 (8 DIMMs)	16 GB ECC Fully Buffered DDR2 (8 DIMMs)	16 GB ECC Fully Buffered DDR2 (8 DIMMs)
<b>Integrated SCSI</b>	No	No	No	No
<b>Integrated LAN</b>	2 x Intel® Gigabit Ethernet Controller	2 x Intel® Gigabit Ethernet Controller	2 x Intel® Gigabit Ethernet Controller	2 x Intel® Gigabit Ethernet Controller
<b>Integrated Graphics</b>	ATI* with 16 MB memory	ATI* with 16 MB memory	ATI* with 16 MB memory	ATI* with 16 MB memory
<b>Server Management Support</b>	Intel® Server Essentials 2.0 Intelligent Platform Management Interface 2.0	Intel® Server Essentials 2.0 Intelligent Platform Management Interface 2.0	Intel® Server Essentials 2.0 Intelligent Platform Management Interface 2.0	Intel® Server Essentials 2.0 Intelligent Platform Management Interface 2.0
<b>Intel® RAID Controller Compatibility<sup>3</sup></b>	Includes Intel® Embedded RAID Technology and compatible with Intel® RAID Controllers	Includes Intel® Embedded RAID Technology and compatible with Intel® RAID Controllers	Includes Intel® Embedded RAID Technology and compatible with Intel® RAID Controllers	Includes Intel® Embedded RAID Technology and compatible with Intel® RAID Controllers
<b>Form Factor</b>	1U Rack	2U Rack	2U Rack	2U Rack
<b>Drive Bays</b>	3 x hot-swap 3.5" SAS HDDs Optional slim-line CD-ROM drive	Up to 6 x 3.5" fixed SATA drives Optional slim-line CD-ROM drive	Up to 6 x 3.5" hot-swap SATA drives Optional slim-line CD-ROM	Up to 6 x 3.5" hot-swap SAS/SATA drives Optional slim-line CD-ROM
<b>System Cooling</b>	2 x fixed cooling blowers with duct 1 x system fan	Supports three system fans	Supports three system fans	Supports three system fans
<b>Power Supply</b>	400-watt PFC non-redundant power supply	600-watt PFC non-redundant power supply	600-watt, dual-line cord 1+1 PFC (fully redundant configuration requires a second power module, order code TLIACPSU003)	600-watt, dual-line cord 1+1 PFC (fully redundant configuration requires a second power module, order code TLIACPSU003)
<b>Dimensions (H x W x D)</b>	1.70" (43mm) x 16.92" (430mm) x 25.51" (648mm)	3.44" (87mm) x 16.93" (430mm) x 25.55" (649mm)	3.44" (87mm) x 16.93" (430mm) x 25.55" (649mm)	3.44" (87mm) x 16.93" (430mm) x 25.55" (649mm)



System	Intel® Server System SR1520ML	Intel® Server System SR1530SH	Intel® Server System SR1530HSH
	<i>Two independent uniprocessor systems in a 1U package for high-performance and high-density computing</i>		
Order Code <sup>1</sup>	<b>SR1520ML</b> <b>SR1520MLNA</b>	<b>SR1530SH</b> <b>SR1530SHNA</b>	<b>SR1530HSH</b> <b>SR1530HSHNA</b>
Components Included	<ul style="list-style-type: none"> <li>Two Intel® Server Boards X38ML</li> <li>Integrated in the Intel® Server Chassis SR1520ML</li> <li>Two Intel® 1U heatsinks</li> <li>Two PCI Express* x16 risers</li> <li>Support for two 2.5" fixed SATA drives</li> <li>600-watt high-efficiency power supply</li> <li>Basic rail kit</li> <li>Pre-routed cables</li> </ul>	<ul style="list-style-type: none"> <li>Intel® Server Board S3200SHVL</li> <li>Intel® Server Chassis with 350-watt power supply</li> <li>System fan and cooling blowers with duct</li> <li>Intel® 1U heatsink</li> <li>Slim-line DVD-ROM bay</li> <li>Basic rail kit</li> <li>Pre-routed cables</li> </ul>	<ul style="list-style-type: none"> <li>Intel® Server Board S3200SHVL</li> <li>Intel® Server Chassis with 350-watt power supply</li> <li>System cooling blowers with duct</li> <li>Intel® 1U heatsink</li> <li>Slim-line DVD-ROM bay</li> <li>Basic rail kit</li> <li>Pre-routed cables</li> </ul>
Number of Processors Supported	2	1	1
Processor Support <sup>2</sup>	<b>Intel® Xeon® 3200 and 3000 series, Intel® Core™2 Duo, Intel® Core™2 Quad, Intel® Core™2 Extreme Dual-Core, and Intel® Core™2 Extreme Quad-Core processors</b>	<b>Intel® Xeon® 3000 and 3200 series, Quad-Core Intel® Xeon® 3300 series, and Dual-Core Intel® Xeon® 3100 series processors</b>	<b>Intel® Xeon® 3000 and 3200 series, Quad-Core Intel® Xeon® 3300 series, and Dual-Core Intel® 3100 series processors</b>
System Bus Speed	1333 MHz <sup>5</sup> / 1066 MHz / 800 MHz	1333 MHz <sup>5</sup> / 1066 MHz / 800 MHz	1333 MHz <sup>5</sup> / 1066 MHz / 800 MHz
Chipset	Intel® X38 Express Chipset	Intel® 3200 Chipset	Intel® 3200 Chipset
PCI Buses	1	6	6
Total Slots	1	1	1
Slot Types	1 x PCI Express 2.0 x16 (2nd Gen. PCIe)	1 x PCI Express* x8	1 x PCI Express* x8
Memory Capacity	4 x DIMM slots for DDR2 667/800 MHz Unbuffered ECC/non-ECC DIMMs (8 GB Max)	4 x DIMM slots for DDR2 667/800 MHz Unbuffered ECC/non-ECC DIMMs (8 GB Max)	4 x DIMM slots for DDR2 667/800 MHz Unbuffered ECC/non-ECC DIMMs (8 GB Max)
Integrated SCSI	No	No	No
Integrated LAN	2 x Intel® Gigabit Ethernet Controller	2 x Intel® Gigabit Ethernet Controller	2 x Intel® Gigabit Ethernet Controller
Integrated Graphics	ServerEngines* iBMC	ServerEngines* iBMC	ServerEngines* iBMC
Server Management Support	Intel® Server Essentials 2.0 Intelligent Platform Management Interface 2.0	Intel® Server Essentials 2.0 Intelligent Platform Management Interface 2.0	Intel® Server Essentials 2.0 Intelligent Platform Management Interface 2.0
Intel® RAID Controller Compatibility <sup>3</sup>	Includes Intel® Embedded RAID Technology and compatible with Intel® RAID Controllers	Includes Intel® Embedded RAID Technology and compatible with Intel® RAID Controllers	Includes Intel® Embedded RAID Technology and compatible with Intel® RAID Controllers
Form Factor	1U short depth rack	1U rack	1U rack
Drive Bays	2 x fixed 2.5" SATA (3.0 Gb/s) HDDs	2 x fixed 3.5" SATA (3.0 Gb/s) HDDs 1 x fixed slim-line DVD-ROM	3 x hot-swap 3.5" SATA (3.0 Gb/s) HDDs 1 x fixed slim-line DVD-ROM
System Cooling	2 x fixed cooling blowers with ducts 2 x system fan	2 x fixed cooling blowers with duct 1 x system fan	2 x fixed cooling blowers with duct
Power Supply	600-watt high-efficiency power supply	350-watt PFC power supply	350-watt non-redundant
Dimensions (H x W x D)	1.70" (43mm) x 16.9" (430mm) x 20.0" (508mm)	1.70" (43mm) x 16.9" (430mm) x 20.0" (508mm)	1.70" (43mm) x 16.92" (430mm) x 25.51" (648mm)



System	Intel® 4-Processor Server System S7000FC4UR <i>Maximum performance, reliability, and scalability</i>	Intel® 4-Processor Server System S7000FC4UR <i>Maximum performance, reliability, and scalability</i>
Order Code <sup>1</sup>	<b>SFC4UR</b> (Value SKU)	<b>SFC4URE</b> (Enterprise SKU)
Components Included	<ul style="list-style-type: none"> <li>One Intel® 4-Processor Server System S7000FC4UR</li> <li>Support for four SATA 2.5" disk drives with integrated RAID</li> <li>One 1570-watt power supply</li> <li>One 8-DIMM memory board (system supports 4 memory boards for a total of 32 DIMM slots)</li> <li>Four hot-swap and redundant fans (front)</li> <li>Two hot-swap fans (rear)</li> <li>Standard control panel</li> <li>Pre-routed cables</li> </ul>	<ul style="list-style-type: none"> <li>One Intel® 4-Processor Server System S7000FC4UR</li> <li>Support for eight SAS/SATA 2.5" disk drives with integrated RAID</li> <li>Two Hot-swap and redundant 1570-watt power supplies</li> <li>One 8-DIMM memory board (system supports 4 memory boards for a total of 32 DIMM slots)</li> <li>Eight hot-swap and redundant fans (four front, four rear)</li> <li>One slimline CD/DVD-ROM</li> <li>I/O expansion module that provides additional dual Gb Ethernet connections</li> <li>Standard control panel</li> <li>Pre-routed cables</li> </ul>
Number of Processors Supported	4	4
Processor Support <sup>2</sup>	<b>Quad-Core Intel® Xeon® 7300 series or Dual-Core Intel® Xeon® 7200 series processors</b>	<b>Quad-Core Intel® Xeon® 7300 series or Dual-Core Intel® Xeon® 7200 series processors</b>
System Bus Speed	1333 MHz <sup>5</sup> / 1066 MHz	1333 MHz <sup>5</sup> / 1066 MHz
Chipset	Intel® 7300 Chipset	Intel® 7300 Chipset
PCI Buses	6	6
Total Slots	7	7
Slot Types	4 x PCI Express* x8 (two hot-plug) 3 x PCI Express x4	4 x PCI Express* x8 (two hot-plug) 3 x PCI Express x4
Memory Capacity	256 GB ECC Fully Buffered DDR2 (via 32 DIMM slots and requires accessory BFCMEM)	256 GB ECC Fully Buffered DDR2 (via 32 DIMM slots and requires accessory BFCMEM)
Integrated SCSI	No	SAS/SATA riser module with Intel® Integrated Server RAID module.
Integrated LAN	2 x Intel® Gigabit Ethernet Controller	4 x Intel® Gigabit Ethernet Controller
Integrated Graphics	ATI ES1000* graphics controller	ATI ES1000* graphics controller
Server Management Support	Intel® Server Essentials 2.0 Intelligent Platform Management Interface 2.0 Support for Intel® Remote Management Module (AXXMM2)	Intel® Server Essentials 2.0 Intelligent Platform Management Interface 2.0 Support for Intel® Remote Management Module (AXXMM2)
Intel® RAID Controller Compatibility (Order Code) <sup>3</sup>	Embedded RAID 0 and 1 Optional SAS/SATA riser module with Intel® Integrated Server RAID module (AFCASRISER) Optional Intel® Integrated RAID activation key with HW RAID support for 0, 1, 5, 6, 10, 50, and 60 (AXXRAKSAS2) Optional Intel® RAID Smart Battery (AXXRSBBU4)	Embedded RAID 0, 1, and 1E Optional Intel Integrated RAID activation key with HW RAID support for 0, 1, 5, 6, 10, 50, and 60 (AXXRAKSAS2) Optional Intel® RAID Smart Battery (AXXRSBBU4)
Form Factor	4U Rack	4U Rack
Drive Bays	Up to 4 x hot-swap 2.5" SATA 1 x 5.25" peripheral bay (empty) Optional slimline CD/DVD-EOM (AFCDVD)	Up to 8 x hot-swap 2.5" SAS/SATA 1 x 5.25" peripheral bay (empty) Slimline CD/DVD-EOM
System Cooling	2 x hot-swap rear fans (full redundancy requires FFC4UBKFAN) 2 x hot-swap and redundant front fans	4 x hot-swap and redundant fans 2 x hot-swap and redundant front fans
Power Supply	Hot-swap 1570-watt, 1+1, power supply (full redundancy requires AFC4UPWR)	Hot-swap and redundant 1570-watt, 1+1 power supply
Dimensions (H x W x D)	6.8" (173mm) x 17.6" (447mm) x 27.8" (706mm)	6.8" (173mm) x 17.6" (447mm) x 27.8" (706mm)

<sup>1</sup> North American power cord included in order codes ending in NA, power cord not included in all other order codes.

<sup>2</sup> Refer to <http://support.intel.com/support/motherboards/server> for up-to-date details on processors supported by each server board.

<sup>3</sup> Refer to [http://support.intel.com/support/motherboards/server/compat\\_matrix.htm](http://support.intel.com/support/motherboards/server/compat_matrix.htm) for up-to-date details on RAID controllers supported by each server system.

<sup>4</sup> 1600 MHz support may require updates that may not be available at launch.

<sup>5</sup> 1333 MHz support may require updates that may not be available at launch.

All products and dates specified are preliminary based on current expectations and are subject to change without notice. Availability in different channels may vary.

Intel, the Intel logo, Intel Core, Pentium, Celeron, and Xeon are trademarks of Intel Corporation in the U.S. and other countries.

\*Other names and brands may be claimed as the property of others.

Copyright © 2008 Intel Corporation. All rights reserved. 1008/RR/MS Part Number: 252629-023US **October 2008**



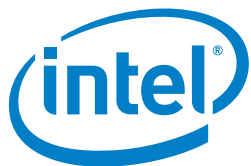

## INTEL® SERVER ADAPTERS

### CONNECTIVITY FOR COPPER NETWORKS

#### 10 GIGABIT-OVER-COPPER



	Intel® 10 Gigabit AT Server Adapter	Intel® 10 Gigabit CX4 Dual Port Server Adapter	Intel® 10 Gigabit AF DA Dual Port Server Adapter
<b>Product Code—Singles</b>	EXPX9501AT	EXPX9502CX4	E10G42AFDA
<b>Product Code—Five Packs</b>	N/A	N/A	N/A
<b>Connector(s)</b>	1 RJ-45	2 CX4	2 SFP+ Direct Attach Copper
<b>End-Brackets</b>	Low-profile and full-height	Low-profile and full-height	Low-profile and full-height
<b>Ethernet Controller(s)</b>	Intel® 82598EB	Intel® 82598EB	Intel® 82598EB
<b>Bus Width and Type</b>	PCI Express* 2.0 (2.5 GT/s) x8	PCI Express* 2.0 (2.5 GT/s) x8	PCI Express* 2.0 (2.5 GT/s) x8

#### 10/100/1000 Mb/s-OVER-COPPER MULTI-PORT



	Intel® PRO/1000 PT Quad Port LP Server Adapter	Intel® PRO/1000 GT Quad Port Server Adapter	Intel® PRO/1000 PT Dual Port Server Adapter
<b>Product Code—Singles</b>	EXPI9404PTL	PWLA8494GT	EXPI9402PT
<b>Product Code—Five Packs</b>	EXPI9404PTLCLK	PWLA8494GTBLK5	EXPI9402PTBLK
<b>Connector(s)</b>	4 RJ-45	4 RJ-45	2 RJ-45
<b>End-Brackets</b>	Low-profile and full-height	Full-height	Low-profile and full-height
<b>Ethernet Controller(s)</b>	Intel® 82571GB	Intel® 82546GB	Intel® 82571GB
<b>Bus Width and Type</b>	PCI Express* x4	64-bit PCI/PCI-X	PCI Express* x4

Help improve a server's reliability, availability, and scalability by adding an Intel® multi-port adapter.

For more information, visit the Intel Web site at: [www.intel.com/network/connectivity/index.htm](http://www.intel.com/network/connectivity/index.htm)

## CONNECTIVITY FOR COPPER NETWORKS

### 10/100/1000 Mb/s-OVER-COPPER MULTI-PORT *continued*



	Intel® PRO/1000 MT Dual Port Server Adapter	Intel® Gigabit ET Quad Port Server Adapter	Intel® Gigabit ET Dual Port Server Adapter
<b>Product Code</b> —Singles	PWLA8492MT	E1G44ET	E1G42ET
<b>Product Code</b> —Five Packs	PWLA8492MTBLK5	E1G44ETBLK	E1G42ETBLK
<b>Connector(s)</b>	2 RJ-45	4 RJ-45	2 RJ-45
<b>End-Brackets</b>	Low-profile and full-height	Low-profile and full-height	Low-profile and full-height
<b>Ethernet Controller(s)</b>	Intel® 82546GB	Intel® 82576	Intel® 82576
<b>Bus Width and Type</b>	32- or 64-bit PCI/PCI-X	PCI Express* x4	PCI Express* x4
<b>Virtual Machine Device Queues (VMDq) Support</b>	N/A	Yes	Yes
<b>Security Features</b>	N/A	IPsec	IPsec

### 10/100/1000 Mb/s-OVER-COPPER SINGLE PORT



### 10/100 Mb/s-OVER-COPPER



	Intel® PRO/1000 PT Server Adapter	Intel® PRO/1000 MT Server Adapter	Intel® PRO/100 S Dual Port Server Adapter	Intel® PRO/100 S Server Adapter
<b>Product Code</b> —Singles	EXPI9400PT	PWLA8490MT	PILA8472C3	PILA8470C3
<b>Product Code</b> —Five Packs	EXPI9400PTBLK	PWLA8490MTBLK5	PILA8472C3PAK5	PILA8470C3PAK5
<b>Connector(s)</b>	1 RJ-45	1 RJ-45	2 RJ-45	1 RJ-45
<b>End-Brackets</b>	Low-profile and full-height	Low-profile and full-height	Full-height	Full-height
<b>Ethernet Controller(s)</b>	Intel® 82572GI	Intel® 82545GM	Intel® 82550GY	Intel® 82550EY
<b>Bus Width and Type</b>	PCI Express* x1	32- or 64-bit PCI/PCI-X	32- or 64-bit PCI	32-bit PCI

## CONNECTIVITY FOR FIBER NETWORKS

### 10 GIGABIT-OVER-FIBER SINGLE PORT



	Intel® 10 Gigabit XF SR Server Adapter	Intel® 10 Gigabit XF LR Server Adapter	Intel® PRO/10GbE SR Server Adapter	Intel® PRO/10GbE LR Server Adapter
<b>Product Code</b> —Singles	EXPX9501AFXSR	EXPX9501AFXLR	PXLA8591SR	PXLA8591LR
<b>Product Code</b> —Five Packs	N/A	N/A	N/A	N/A
<b>Connector(s)</b>	1 LC	1 SC	1 LC	1 SC
<b>Fiber Optic Cabling</b>	MMF 62.5/50µm up to 300m	SMF up to 10km	MMF 62.5/50µm up to 300m	SMF up to 10km
<b>End-Brackets</b>	Low-profile and full-height	Low-profile and full-height	Full-height	Full-height
<b>Ethernet Controller(s)</b>	Intel® 82598EB	Intel® 82598EB	Intel® 82597EX	Intel® 82597EX
<b>Bus Width and Type</b>	PCI Express* 2.0 (2.5 GT/s) x8	PCI Express* 2.0 (2.5 GT/s) x8	64-bit PCI/PCI-X	64-bit PCI-X

### 10 GIGABIT-OVER-FIBER MULTI-PORT



### GIGABIT-OVER-FIBER MULTI-PORT

	Intel® 10 Gigabit XF SR Dual Port Server Adapter	Intel® PRO/1000 PF Quad Port Server Adapter	Intel® PRO/1000 PF Dual Port Server Adapter	Intel® PRO/1000 MF Dual Port Server Adapter	Intel® Gigabit EF Dual Port Server Adapter
<b>Product Code</b> —Singles	EXPX9502AFXSR	EXPI9404PF	EXPI9402PF	PWLA8492MF	E1G42EF
<b>Product Code</b> —Five Packs	N/A	EXPI9404PFBLK	EXPI9402PFBLK	PWLA8492MFBLK5	E1G42EFBLK
<b>Connector(s)</b>	2 LC	4 LC	2 LC	2 LC	2 LC
<b>Fiber Optic Cabling</b>	MMF 62.5/50µm up to 300m	MMF 62.5/50µm up to 275m	MMF 62.5/50µm up to 275m	MMF 62.5/50µm up to 275m	MMF 62.5/50µm up to 275m
<b>End-Brackets</b>	Low-profile and full-height	Full-height	Low-profile and full-height	Low-profile and full-height	Low-profile and full-height
<b>Ethernet Controller(s)</b>	Intel® 82598EB	Intel® 82571GB	Intel® 82571GB	Intel® 82546GB	Intel® 82576
<b>Bus Width and Type</b>	PCI Express* 2.0 (2.5 GT/s) x8	PCI Express* x4	PCI Express* x4	64-bit PCI/PCI-X	PCI Express* x4
<b>Virtual Machine Device Queues (VMDq) Support</b>	N/A	N/A	N/A	N/A	Yes
<b>Security Features</b>	N/A	N/A	N/A	N/A	IPsec

## CONNECTIVITY FOR FIBER NETWORKS

### GIGABIT-OVER-FIBER SINGLE PORT



	Intel® PRO/1000 PF Server Adapter	Intel® PRO/1000 MF Server Adapter	Intel® PRO/1000 MF Server Adapter (LX)
<b>Product Code</b> —Singles	EXPI9400PF	PwLA8490MF	PwLA8490LX
<b>Product Code</b> —Five Packs	EXPI9400PFBLK	PwLA8490MFBLK5	PwLA8490LXBLK5
<b>Connector(s)</b>	1 LC	1 LC	1 LC
<b>Fiber Optic Cabling</b>	MMF 62.5/50µm up to 275m	MMF 62.5/50µm up to 275m	SMF 9µm up to 10km, MMF 62.5/50µm up to 550m
<b>End-Brackets</b>	Full-height	Low-profile and full-height	Low-profile and full-height
<b>Ethernet Controller(s)</b>	Intel® 82572GI	Intel® 82545GM	Intel® 82545GM
<b>Bus Width and Type</b>	PCI Express* x4	32- or 64-bit PCI/PCI-X	32- or 64-bit PCI/PCI-X

All products and dates specified are preliminary based on current expectations and are subject to change without notice. Availability in different channels may vary. Intel and the Intel logo are trademarks of Intel Corporation in the U.S. and other countries.

\*Other names and brands may be claimed as the property of others.

Copyright © 2008 Intel Corporation. All rights reserved. 1008/RR/MS Part Number: 252631-024US **October 2008**

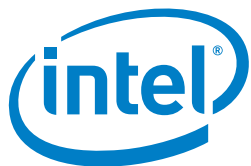

## INTEL® RAID CONTROLLERS



Controller	Intel® RAID Controller SRCASPH161	Intel® RAID Controller SRCASJV	Intel® RAID Controller SRCASBB81	Intel® RAID Controller SRCASRB
	A full-featured sixteen-port SAS/SATA RAID controller for high-disk count solutions	Configurable internal/external eight-port SAS/SATA RAID for high-performance flexible solutions	Eight-port internal SAS/SATA RAID in a low-profile, MD2-compliant form factor for mainstream to performance solutions	Eight-port internal SAS/SATA RAID for mainstream solutions
Order Code	<b>SRCSASPH161</b> <b>AXXRSBBU3</b> (Optional Intel® RAID Smart Battery)	<b>SRCSASJV</b> <b>AXXRPCM3</b> (Optional Intel® Portable Cache Module) <b>AXXRSBBU3</b> (Optional Intel® RAID Smart Battery)	<b>SRCSASBB81</b> <b>AXXRSBBU6</b> (Optional Intel® RAID Smart Battery)	<b>SRCSASRB</b> <b>AXXRSBBU4</b> (Optional Intel® RAID Smart Battery)
Processor Support	Intel® IOP333 I/O Processor 500 MHz	N/A	N/A	N/A
RAID On Chip	N/A	LSI* 1078	LSI* 1078	LSI* 1078
Memory	Embedded 256 MB ECC SDRAM	Ships with 512 MB DIMM (Supports up to 1 GB mini-DIMM ECC DDR2 667 MHz SDRAM)	Embedded 256 MB ECC SDRAM	Embedded 256 MB ECC SDRAM
PCI Bus	PCI Express* x8	PCI Express* x8	PCI Express* x8	PCI Express* x4
Channels	16 internal SAS/SATA ports supporting point-to-point 3.0 Gb/s data-transfer rates	8 SAS/SATA ports configurable in groups of 4 for up to 8 internal or 8 external ports supporting point-to-point 3.0 Gb/s data-transfer rates	8 internal SAS/SATA ports supporting point-to-point 3.0 Gb/s data-transfer rates	8 internal SAS/SATA ports supporting point-to-point 3.0 Gb/s data-transfer rates
Form Factor	Full-height, 6.6" length	Low-profile, 8.25" length	Low-profile, 6.6" length	Low-profile, 7.75" length
RAID Levels	0, 1, 5, 6, 10, 50, and 60	0, 1, 5, 6, 10, 50, and 60	0, 1, 5, 6, 10, 50, and 60	0, 1, 5, 6, 10, 50, and 60
Battery Backup	Yes (Optional - purchased separately)	Yes (Optional - purchased separately)	Yes (Optional - purchased separately)	Yes (Optional - purchased separately)
Availability	Now	Now	Now	Now

For more information, visit the Intel Web site at: [www.intel.com/products/server/raid](http://www.intel.com/products/server/raid)

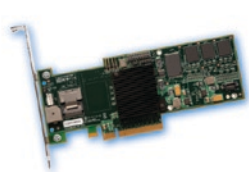

Controller	Intel® RAID Controller SRCASLS4I	Intel® RAID Controller SRCATAWB	Intel® RAID Controller SASMF8I	Intel® RAID Controller SASUC4I	Intel® RAID Controller SRCAS144E
	Four-port internal SAS/SATA RAID in a low-profile, MD2-compliant form factor for entry-level to mainstream solutions	Eight-port Serial ATA RAID supporting up to 16 HDD through an expander backplane for entry-level to mainstream solutions	Eight-port SAS/SATA card with host-based RAID capability for entry-level RAID solutions	Four-port SAS/SATA with pass through and entry-level hardware RAID 0/1/1E/10E capability	Four-port internal and four-port external SAS/SATA RAID for mainstream solutions requiring external connectivity
Order Code	<b>SRCSASLS8I</b> <b>AXXRSBBU6</b> (Optional Intel® RAID Smart Battery)	<b>SRCSATAWB</b> <b>AXXRSBBU4</b> (Optional Intel® RAID Smart Battery)	<b>SASMF8I</b>	<b>SASUC4I</b>	<b>SRCSAS144E</b> <b>AXXRSBBU3</b> (Optional Intel® RAID Smart Battery)
Processor Support	N/A	N/A	N/A	N/A	<b>Intel® IOP333 I/O Processor 500 MHz</b>
RAID On Chip	LSI* 1078	LSI* 1078	N/A	LSI* 1064	N/A
Memory	Embedded 128 MB ECC SDRAM	Embedded 128 MB ECC SDRAM	N/A	N/A	Embedded 128 MB
PCI Bus	PCI Express* x8	PCI Express* x4	PCI Express* x4	PCI Express* x4	PCI Express* x4
Channels	4 internal SAS/SATA ports supporting point-to-point 3.0 Gb/s data-transfer rates	8 internal Serial ATA ports with 3.0 Gb/s data-transfer rates	8 internal SAS/SATA ports supporting point-to-point 3.0 Gb/s data-transfer rates	4 internal SAS/SATA ports supporting point-to-point 3.0 Gb/s data-transfer rates	4 internal and 4 external ports supporting point-to-point 3.0 Gb/s data-transfer rates
Form Factor	Low-profile, 6.6" length	Low-profile, 7.75" length	Low-profile, 6.6" length	Low-profile, 6.6" length	Low-profile, 3/4 length
RAID Levels	0, 1, 5, 6, 10, 50, and 60	0, 1, 5, 6, 10, 50, and 60	0, 1, 5, and 10	0, 1, and 1E/10E	0, 1, 5, 10, and 50
Battery Backup	Yes (Optional - purchased separately)	Yes (Optional - purchased separately)	No	No	Yes (Optional - purchased separately)
Availability	Now	Now	Now	October 2008	Now

All products and dates specified are preliminary based on current expectations and are subject to change without notice. Availability in different channels may vary.

Intel and the Intel logo are trademarks of Intel Corporation in the U.S. and other countries.

\*Other names and brands may be claimed as the property of others.

Copyright © 2008 Intel Corporation. All rights reserved. 1008/RR/MS Part Number: 252627-023US **October 2008**

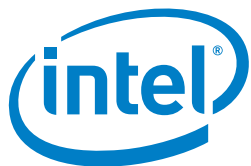

## INTEL® MANAGEMENT MODULES



Feature Description	Intel® Management Module- Professional Edition	Intel® Management Module- Advanced Edition	Intel® Remote Management Module 2
<b>Positioning</b>	Maintain high-availability servers over serial, modem, or LAN.	Take remote control of servers with a cost-effective solution, including enhanced video/GUI redirection over Internet protocols and agent-less embedded management services.	Have remote, secure access to full-screen KVM features together with hardware-health monitoring, remote CD or USB access, and complete power control without ever having to visit the server.
<b>Order Code</b>	<b>AXXIMMPRO</b>	<b>AXXIMMADV</b>	<b>AXXRMM2</b>
<b>Boards and Systems Support<sup>1</sup></b>	Intel® Server Boards SE7520BD2, SE7520AF2, and SE7520JR2	Intel® Server Boards SE7520BD2, SE7520AF2, and SE7520JR2	Intel® Server Boards S5000PAL, S5000XAL, S5000PSL, S5000XSL, and S5400SF Intel® Server Systems SR1500AL, SR1550AL, SR2500ALBRP, SR2500ALLX, SR1550ALSAS, SR1500ALSAS, S7000FC4UR, SR1560SF, and SR1560SFHS
<b>Remote Server Restart</b>	X	X	X
<b>OEM Customization</b>			X
<b>USB Media Redirection</b>			X
<b>Hardware Sensor Monitoring</b>	X	X	Support built into system firmware
<b>Text Console Redirection (Serial over LAN)</b>	X IPMI 2.0	X Enhanced <sup>2</sup>	IPMI 2.0 SOL support built into system firmware
<b>SNMP</b>	X In-band agent	X Embedded <sup>3</sup>	Support built into system firmware
<b>Embedded Telnet server (Proxy-less CLI Operations)</b>		X	
<b>Soft Keyboard via KVM (Multiple Language Support)</b>			X
<b>LDAP, SSH, RADIUS, SSL support</b>			X
<b>SMASH CLP support</b>			X
<b>WS-MAN</b>			X
<b>Embedded video/GUI (KVM) redirection</b>		X with Intel® ARSC	X
<b>Embedded Web Server</b>		X	X
<b>Dedicated Server Management NIC</b>		X	X
<b>Agent-less Management</b>		X	X

<sup>1</sup> For the latest server board support please visit <http://support.intel.com/support/motherboards/server>

<sup>2</sup> Enhanced reliability (TCP based)

<sup>3</sup> Embedded features work in any OS environment

All products and dates specified are preliminary based on current expectations and are subject to change without notice. Availability in different channels may vary.

Intel and the Intel logo are trademarks of Intel Corporation in the U.S. and other countries.

\*Other names and brands may be claimed as the property of others.

Copyright © 2008 Intel Corporation. All rights reserved. 1008/RR/MS Part Number: 301210-016US **October 2008**



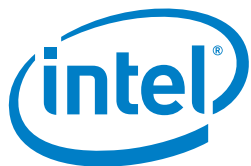

## INTEL® STORAGE SYSTEMS



System	Intel® Entry Storage System SS4200-E	Intel® Storage System SSR212MC2
	An easy-to-use, affordable NAS appliance with simple software to help you easily manage your ever-expanding data	High-density, dual-core-based 2U storage server platform that can be coupled with one of a number of different industry software solutions to create a SAN, NAS, or DAS appliance
Order Code	<b>SS4200E</b>	<b>SSR212MC2-R</b> (with optional RAID controller)
Processor Support	<b>Intel® Celeron® 420 Processor</b>	<b>Multi-Core Intel® Xeon® Processor</b>
Number of Processors Supported	1	1 or 2 (5100 or E5300 series CPUs; 5200 and E5400 series CPUs on BR skus)
System Bus Speed	800 MHz	1066 or 1333 MHz
Chipset	Intel® D945GZ Chipset	Intel® S5000P Chipset
Independent PCI Buses	N/A	5
Total Slots	N/A	5 (four available) (RAID sku) 5 (non-RAID sku)
Slot Types	N/A	One PCI Express* x8, two PCI Express x4, one PCI-X 133 MHz (RAID sku) Two PCI Express x8, two PCI Express x4, one PCI-X 133/100 MHz (non-RAID sku)
Memory Capacity	512 MB	32 GB DDR2 533/667, FBDIMM, Reg ECC
Integrated LAN	1 x Gigabit Ethernet connections	2 x Gigabit Ethernet connections
Integrated Fibre Channel	N/A	N/A
Integrated Graphics	N/A	ATI ES1000* with 16 MB memory
Server Management Support	N/A	Intel® System Management Software 3.0
RAID Support	Supports RAID 1, 5, and 10	Supports RAID 0, 1, 5, 10, and 50
Form Factor	Tabletop	2U Rack mount
Drive Interfaces	4 x 3.5" tool-less non-hot-swap SATA II	12 x 3.5" hot-swap SAS or SATA II
Power Supply	250-watt continuous power supply	850-watt, dual-line cord 1+1 PFC (fully redundant configuration requires second power module, order code AMCB50WPS)
Software	Fully integrated NAS management software from EMC* with EMC Retrospect* Client Backup and Recovery application Other certified NAS software options available	Device driver software, enclosure monitoring software

For more information, visit the Intel Web site at: [www.intel.com/go/storagesystems](http://www.intel.com/go/storagesystems)

All products and dates specified are preliminary based on current expectations and are subject to change without notice. Availability in different channels may vary.

Intel, the Intel logo, Xeon, and Celeron are trademarks of Intel Corporation in the U.S. and other countries.

\* Other names and brands may be claimed as the property of others.

Copyright © 2008 Intel Corporation. All rights reserved. 1008/RR/MS Part Number: 310751-011US **October 2008**





## INTEL® MODULAR SERVER PRODUCTS



<b>Server</b>	<b>Intel® Modular Server Compute Module MFS5000SI</b> <i>High-performance, power- and heat-efficient Intel® 64-bit-capable, multi-core server</i>
<b>Order Code</b>	<b>MFS5000SI</b>
<b>Intel® Server Chassis Support</b>	Intel® Modular Server System MFSYS25 Intel® Modular Server System MFSYS35
<b>Processor Support</b>	<b>Multi-Core Intel® Xeon® processor</b>
<b>Number of Processors Supported</b>	2
<b>System Bus Speed</b>	1333 MHz or 1066 MHz
<b>Chipset</b>	Intel® 5000P Server Chipset
<b>Independent PCI Buses</b>	2
<b>Total Slots</b>	1 Mezzanine Expansion Connector
<b>Onboard HDD</b>	None
<b>Memory Capacity</b>	32 GB FBDIMMS (8 DIMMS)
<b>Integrated SAS HBA</b>	Connectivity to shared storage provided via onboard LSI* 1064e controller
<b>Integrated LAN</b>	2x Gigabit Ethernet (4x with optional gigabit mezzanine card AXXGBIOMEZ)
<b>Integrated Graphics</b>	ATI* ES1000 16 MB Video Controller
<b>Integrated Management</b>	Remote management (KVM over IP) provided via onboard management controller
<b>H/W Management</b>	Easy-to-use h/w deployment and remote management provided by Intel® Modular Control software integrated with Intel® Modular Server Management Module
<b>Application Management</b>	Provided by Intel® System Management Software 2.0
<b>Front Connectors</b>	2 x USB, 1 DB15 video

<b>Chassis</b>	<b>Intel® Modular Server System MFSYS25/MFSYS35</b> <i>One system that integrates storage, compute, and networking to simplify the demands of your business</i>
<b>Chassis Order Code</b>	<b>MFSYS25 / MFSYS35</b>
<b>Spares Kit Order Code</b>	See <a href="http://support.intel.com">support.intel.com</a> for a complete configuration guide
<b>Form Factor</b>	6U (can be deployed in a rack or pedestal kit)
<b>Intel® Server Board Support</b>	<b>Intel® Modular Server Compute Module MFS5000SI</b>
<b>Server Slots</b>	6
<b>Shared Storage HDD Bay</b>	Supports up to 14 x 2.5" drives or 6 x 3.5" drives (MFSYS35)
<b>Management Module Bay</b>	1 integrated Intel® Modular Server Management Module
<b>Storage Module Bays</b>	1 integrated Intel® Storage Controller, option for redundant storage module
<b>IO Module Bays</b>	1 integrated Intel® Gigabit Ethernet Switch, option for redundant Ethernet switch
<b>System Cooling</b>	Includes three high-flow system fans
<b>Power Supply</b>	1000-watt, N+1 PFC 100V-240 V-capable, 2 included
<b>Redundant Power Capable</b>	Yes (fully redundant system configuration requires two additional power modules AXXPUSU)
<b>Tool-less Features</b>	Complete tool-less serviceability
<b>Dimensions (H x W x D)</b>	10.3" x 17.5" x 28.4"
<b>Weight</b>	187 lbs (84.8 kg) fully configured
<b>Ethernet Switch Module</b>	10 External 10/100/1000 Mb/s ports, 12 Internal 1 Gb/s ports, Layer 2+, 10 Gb/s switch inter-links, Integrated management
<b>Storage Controller Module</b>	SAS 3 Gb-based SAN storage supporting RAID 0, 1, 1E, 5, 6, 10, 50, and 60; external x4 mini SAS port expansion for integration with external SAS tape or RAID
<b>Chassis Management Module</b>	Web management GUI with remote KVM support, virtual presence, and virtualized access storage management

For more information, visit the Intel Web site at: [www.intel.com/go/mft](http://www.intel.com/go/mft)

All products and dates specified are preliminary based on current expectations and are subject to change without notice. Availability in different channels may vary.

Intel, the Intel logo, and Xeon are trademarks of Intel Corporation in the U.S. and other countries.

\* Other names and brands may be claimed as the property of others.

Copyright © 2008 Intel Corporation. All rights reserved. 1008/RR/MS Part Number: 310750-010US October 2008



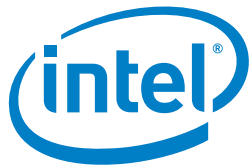

# Intel® Enabled Server Acceleration Alliance (Intel® ESAA)



The Intel® Enabled Server Acceleration Alliance (Intel® ESAA) is a collaboration between Intel and independent software vendor members that enables resellers to deliver pre-tested, high-quality Intel®-based server solutions based on Intel® Server Boards and Systems. Reseller benefits include:

- **Faster time to market using pre-tested solution recipes that provide step-by-step configuration instructions**
- **Reduced engineering costs with access to pre-validated and proven technologies**
- **Pass-through certification from companies such as VMware, RedHat, and Novell.**
- **Alignment with Intel's world-class server technology leadership and pre- and post-sales support infrastructure**



## Gain a Competitive Edge

Intel ESAA is free for Intel® Channel Partner Program members to join<sup>1</sup> and provides comprehensive resources to sell complete solutions instead of just hardware components. Helping resellers build customer loyalty by meeting more complex requirements rapidly, Intel ESAA provides instant access to pre-verified solution stacks from vendors around the globe. These solutions give insight into newly introduced hardware and software, so resellers can get to market early with leading-edge technologies—and stay ahead of the competitive curve.

## Intel® ESAA – A Recipe For Success

Getting components from different vendors to work seamlessly in a single, reliable solution is a challenge. And with so many vendors in the marketplace, validation has become critical. That's where the Intel ESAA program comes in, giving resellers access to hardware and software solution recipes that provide pre-validated configurations and development specifications.

Finding ways to compete with large companies that have seemingly unlimited resources is difficult for any company—especially small ones. Server solution sales can help expand revenue channels and increase sales. End customers want solutions that feature the latest technologies—without deployment or troubleshooting headaches. While the pitfalls to building successful solutions are plenty, the potential rewards offer exceptional future growth.

The collaborative community of Intel ESAA connects resellers, VARs, and system integrators with industry-leading software and hardware companies to reduce barriers to validation, expand market opportunities, and accelerate the delivery of trusted solutions to end customers.

## Ongoing World-Class Support

As a worldwide technology community, Intel ESAA encourages open communication facilitated by the non-profit Technical Support Alliance Network (TSANet) organization to promote a healthy and thriving business ecosystem. This collaboration leads to the reliable and seamless integration of Intel Server Products with solutions offered by our members. And all Intel ESAA members benefit from an improved server ecosystem where collaboration streamlines validation.

As the Intel ESAA community continues to grow, Intel plans to expand opportunities and new markets for members and further reduce barriers to certification. The Intel ESAA program gives resellers the tools they need to accelerate the delivery of high-quality server solutions, reach new customers, and achieve even greater success.

For more information, visit the Intel Web site at: [www.intel.com/go/esaa](http://www.intel.com/go/esaa)



<sup>1</sup> Membership to the Technical Support Alliance Network (TSANet) is required; there is no fee for reseller members but there is a US \$1,500 fee for IxV members. See [www.tsanet.org/](http://www.tsanet.org/) for more information.

Intel and the Intel logo are trademarks of Intel Corporation in the U.S. and other countries.

\*Other names and brands may be claimed as the property of others.

Copyright © 2008 Intel Corporation. All rights reserved. 1008/RR/MS Part Number: 319437-003US **October 2008**

Intel® Desktop Processors  
Intel® Desktop Boards  
Intel® Desktop Adapters  
Intel® Graphics Product Matrix  
Intel® Mobile Processors  
Intel® PRO/Wireless Network Connections  
Intel® Server/Workstation Processors  
Intel® Server Boards  
Intel® Server Essentials  
Intel® Server Chassis  
Intel® Server Systems  
Intel® Server Adapters  
Intel® RAID Controllers  
Intel® Management Modules  
Intel® Storage Systems  
Intel® Modular Server Products  
Intel® Enabled Server Acceleration Alliance

[www.intel.com/go/desktopprocessors](http://www.intel.com/go/desktopprocessors)  
[www.intel.com/products/motherboard/](http://www.intel.com/products/motherboard/)  
[www.intel.com/network/connectivity/index.htm](http://www.intel.com/network/connectivity/index.htm)  
[www.intel.com/go/graphics](http://www.intel.com/go/graphics)  
[www.intel.com/go/notebooks](http://www.intel.com/go/notebooks)  
[www.intel.com/network/connectivity/products/wireless/index.htm](http://www.intel.com/network/connectivity/products/wireless/index.htm)  
[www.intel.com/go/serverprocessors](http://www.intel.com/go/serverprocessors)  
[www.intel.com/go/serverboards](http://www.intel.com/go/serverboards)  
[www.intel.com/go/serveressentials](http://www.intel.com/go/serveressentials)  
[www.intel.com/products/server/chassis](http://www.intel.com/products/server/chassis)  
[www.intel.com/go/serversystems](http://www.intel.com/go/serversystems)  
[www.intel.com/network/connectivity/index.htm](http://www.intel.com/network/connectivity/index.htm)  
[www.intel.com/products/server/raid](http://www.intel.com/products/server/raid)  
[www.intel.com/go/serverbuilder](http://www.intel.com/go/serverbuilder)  
[www.intel.com/go/storagesystems](http://www.intel.com/go/storagesystems)  
[www.intel.com/go/mft](http://www.intel.com/go/mft)  
[www.intel.com/go/esaa](http://www.intel.com/go/esaa)

All products and dates specified are preliminary based on current expectations and are subject to change without notice. Availability in different channels may vary.

Intel, the Intel logo, Intel SpeedStep, Intel Viiv, Intel vPro, vPro Inside, Centrino, Centrino Inside, Intel Core, Core Inside, Pentium, Pentium Inside, Xeon, Xeon Inside, Celeron, Celeron Inside, Intel Atom, and Intel Atom Inside are trademarks of Intel Corporation in the U.S. and other countries.

\*Other names and brands may be claimed as the property of others.

Copyright © 2008 Intel Corporation. All rights reserved.  
1 008/RR/MS 252740-025US Q4 **October 2008**

